



# Profils de moulures

Édition 2012 volume 1

[sabec.ca](http://sabec.ca)

# Table des matières

Table of contents



<b>B</b>	Cadre de panneaux / panels frame .....	05
<b>B</b>	Montant et traverse / rail and stile .....	09
<b>B</b>	Panneau surélevé / raised panel .....	15
<b>C</b>	Cadrage / casing .....	17
<b>D</b>	Moulure de porte / door moulding .....	27
<b>E</b>	Encadrement / picture frame .....	31
<b>F</b>	Finition extérieure / outside finition .....	35
<b>G</b>	Moulure couronnée / crown moulding.....	39
<b>H</b>	Cimaise / chair rail .....	53
<b>L</b>	Lambris / wood paneling.....	60
<b>M</b>	Main-courante / handrail .....	63
<b>N</b>	Multi-profil / multi-profiles .....	67
<b>P</b>	Plinthe / baseboard .....	71
<b>Q</b>	Profil standard / standard profile .....	83
<b>R</b>	Rosette .....	87
<b>S</b>	Appliqué / astragal .....	91
<b>T</b>	Embouveté / tongue and groove .....	93
<b>V</b>	Corniche / cornice .....	97

# Cadre de panneaux

panels frame

ÉCHELLE 1:1

# Cadre de panneaux

panels frame

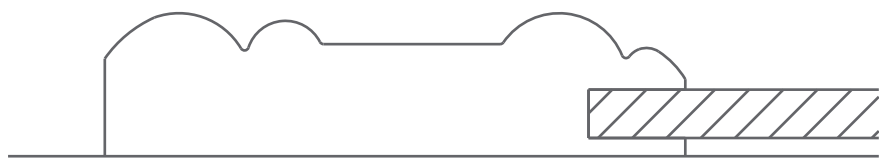

**BO01**

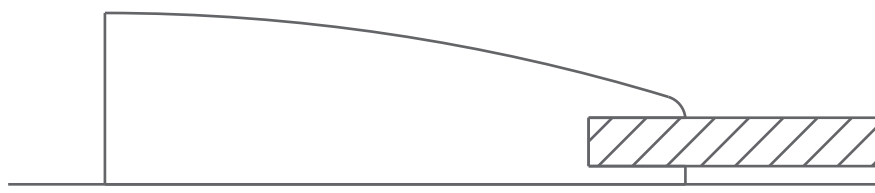

**BO02**

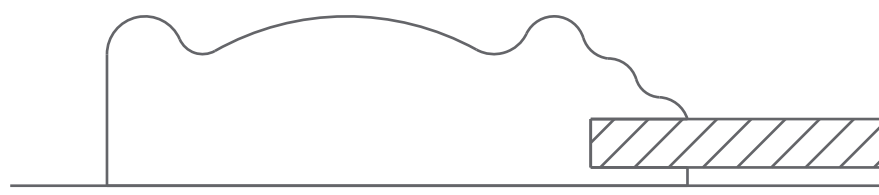

**BO03**



**BO04**

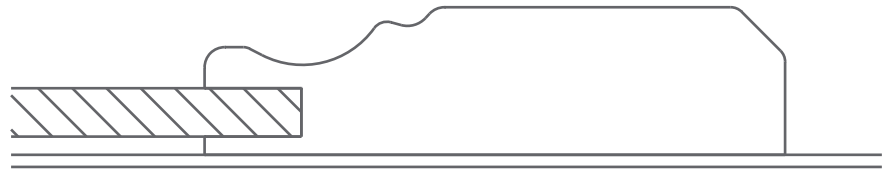

**BO05**



**BO06**



**BO07**

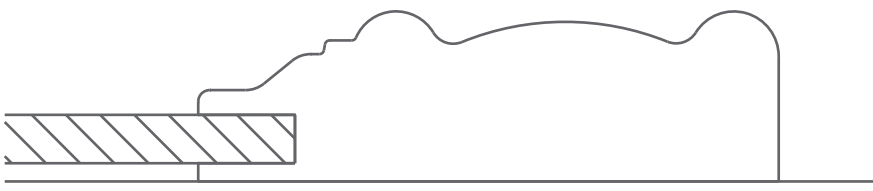

**BO08**

# Cadre de panneaux

panels frame

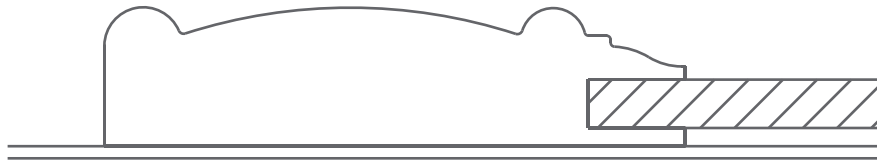

**BO09**

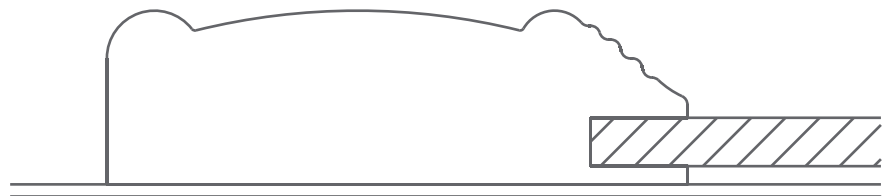

**BO10**

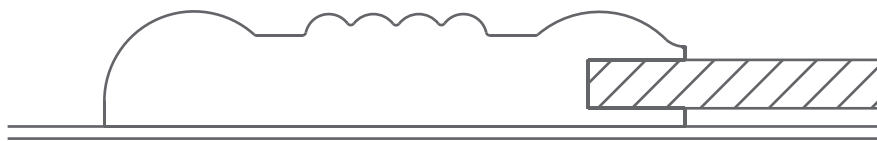

**BO11**

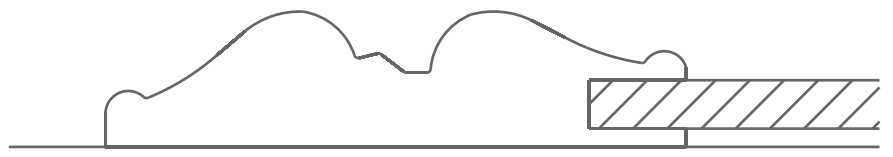

**BO12**

# Montant et traverse

rail and stile

ÉCHELLE 1:1

# Montant et traverse

rail and stile

# panneau

panel

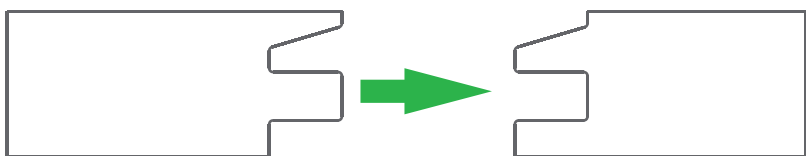
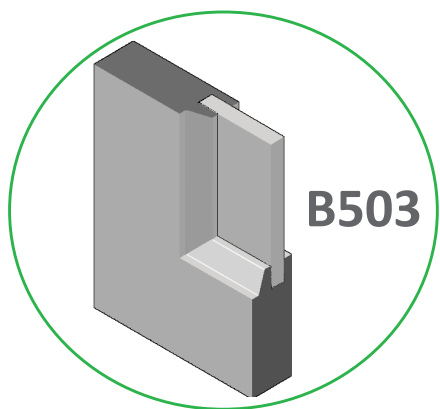
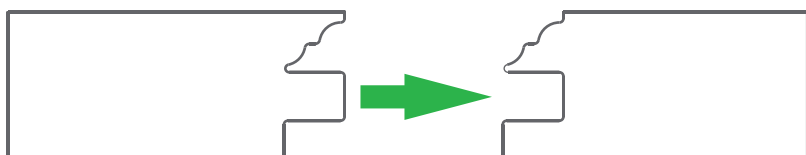
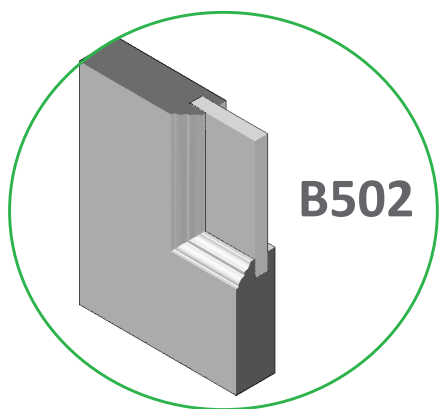
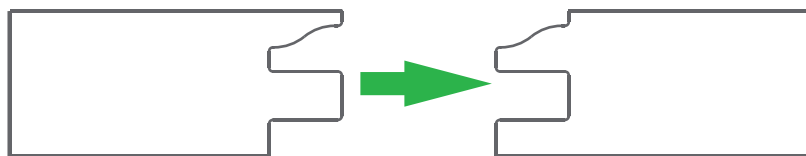
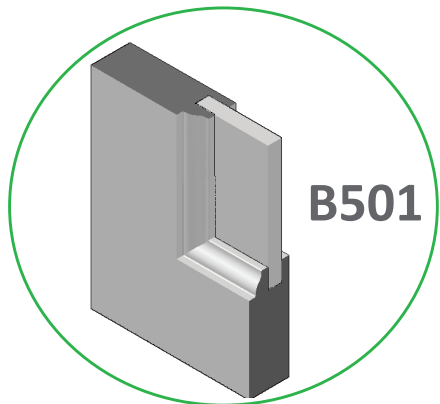



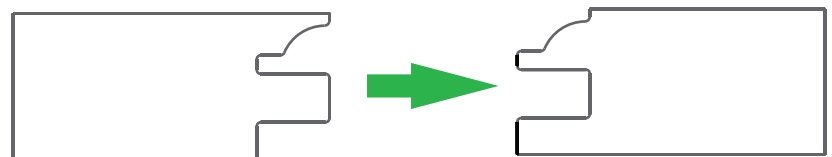
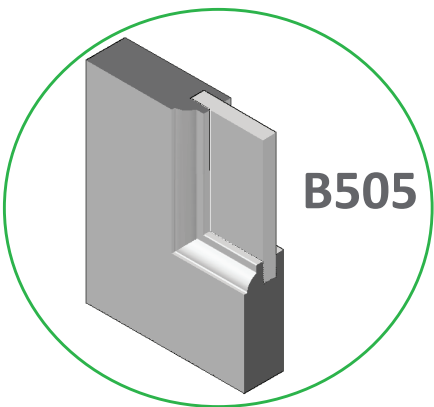
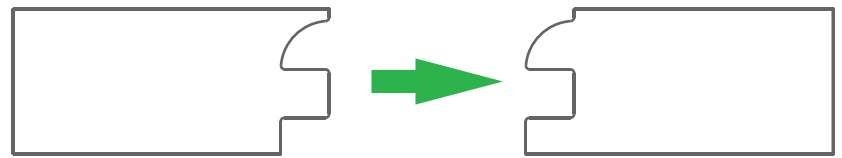
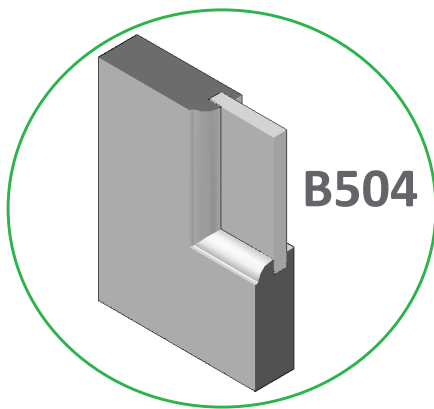

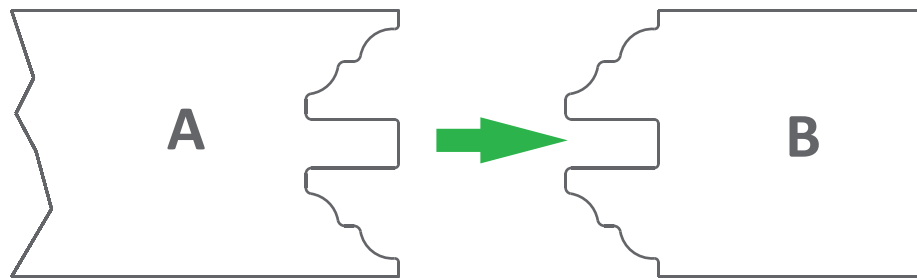
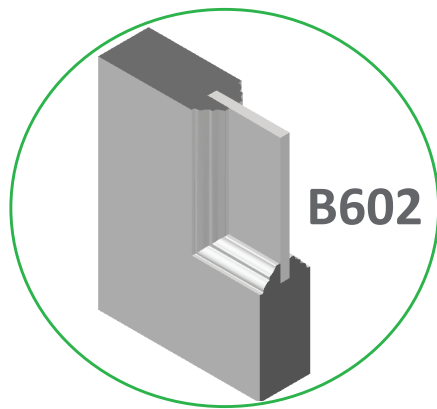
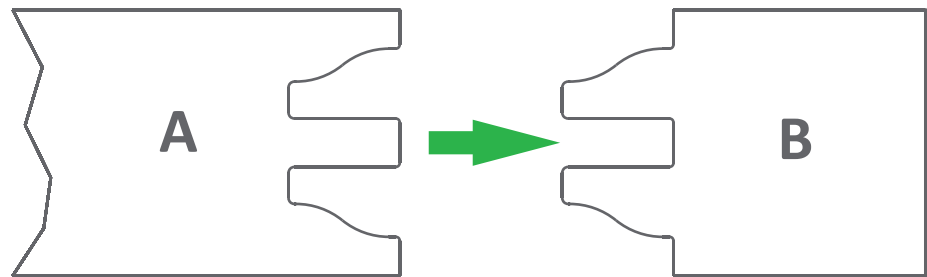
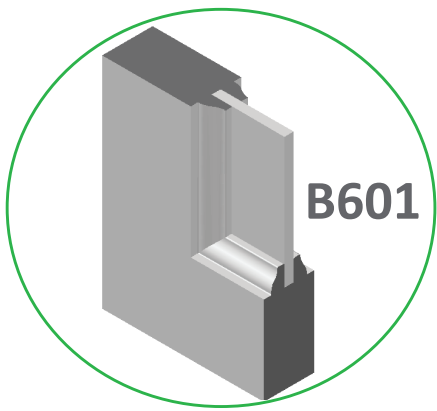

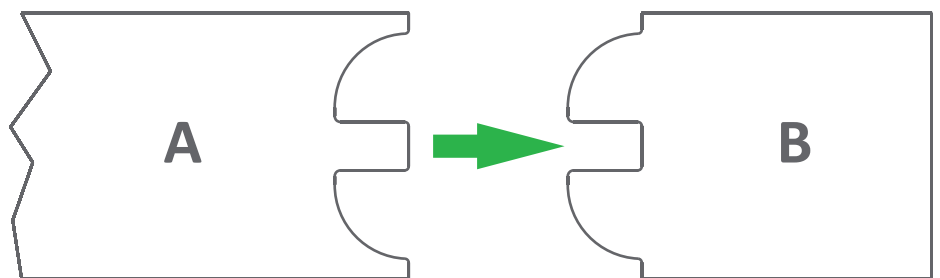
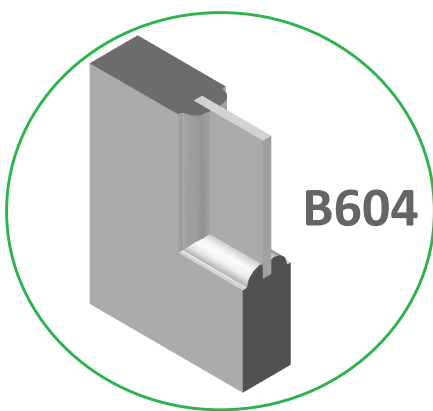
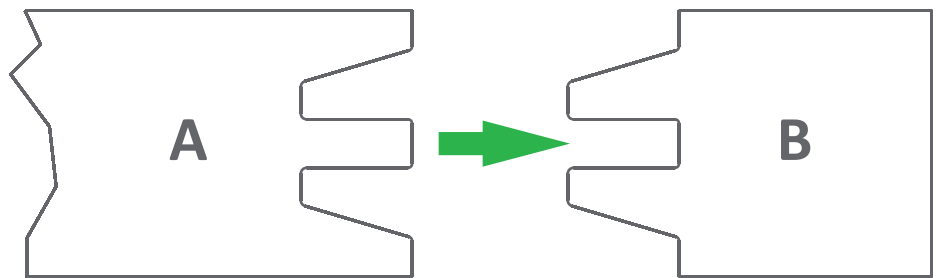
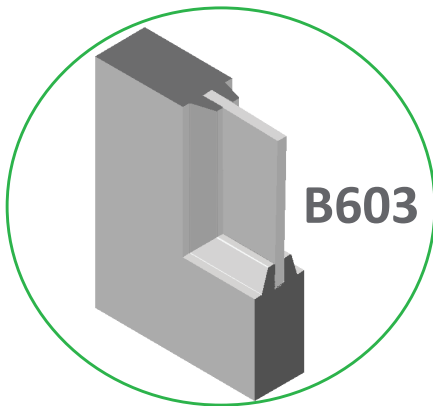

# Montant et traverse

rail and stile

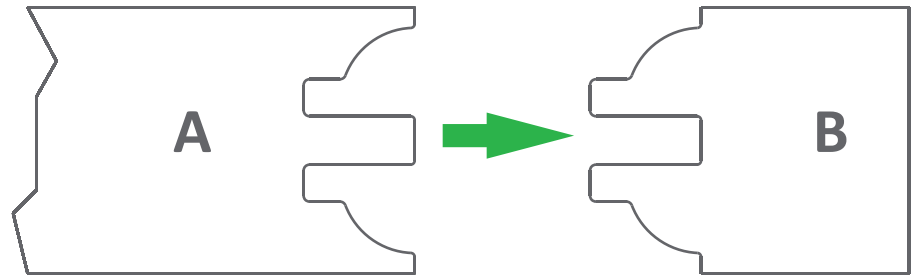
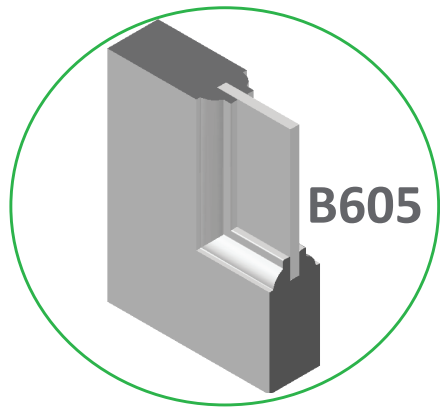

# Panneau surélevé

raised panel

ÉCHELLE 1:1

# Panneau surélevé

raised panel

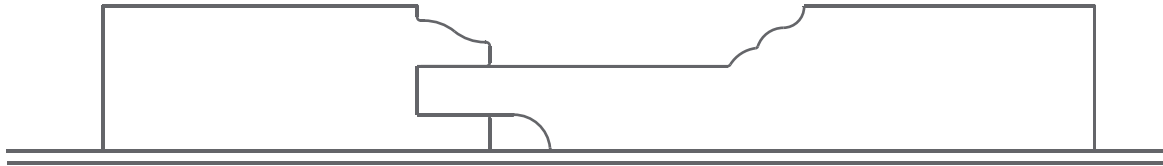

**B701**

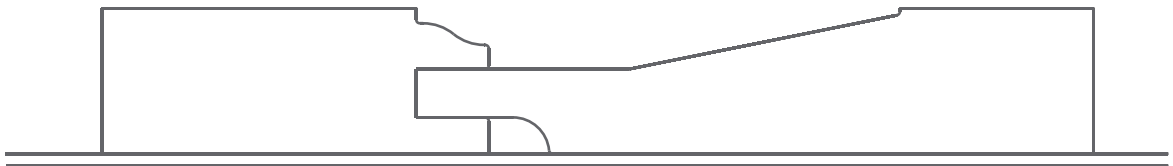

**B702**

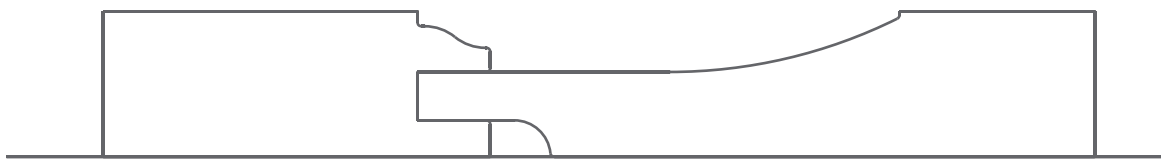

**B703**

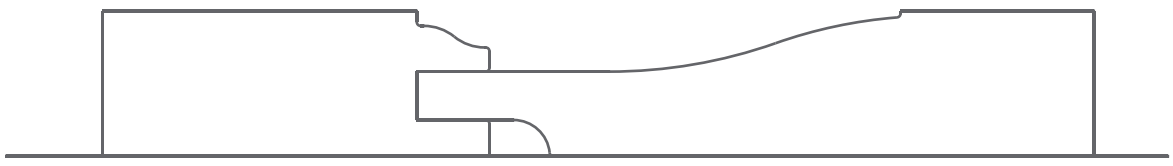

**B704**

# Cadrage

casing

## couteau pour fabriquer l'arrière des cadres

Knife to make back of casings

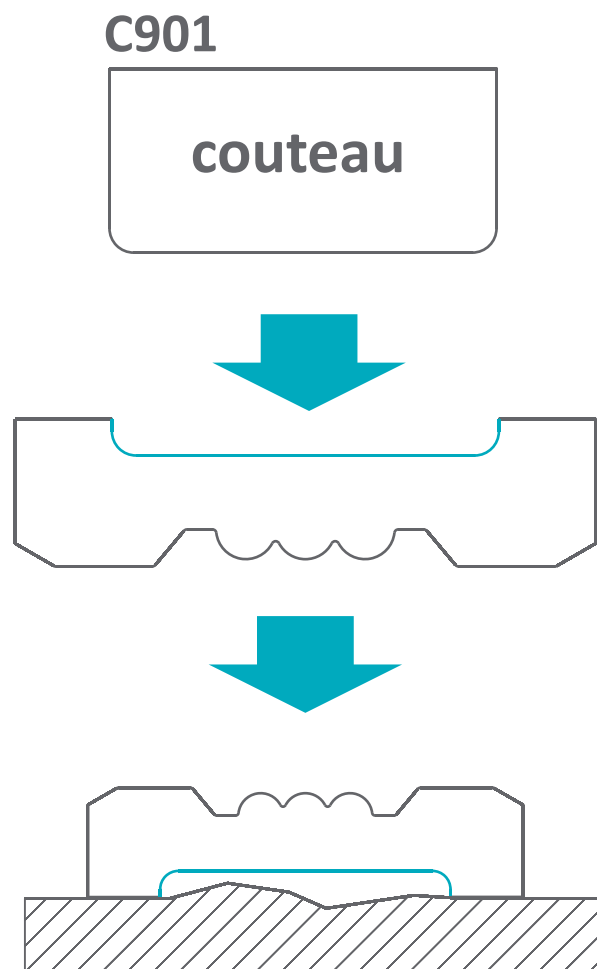



## couteau pour fabriquer l'arrière des cadres

Knife to make back of casings

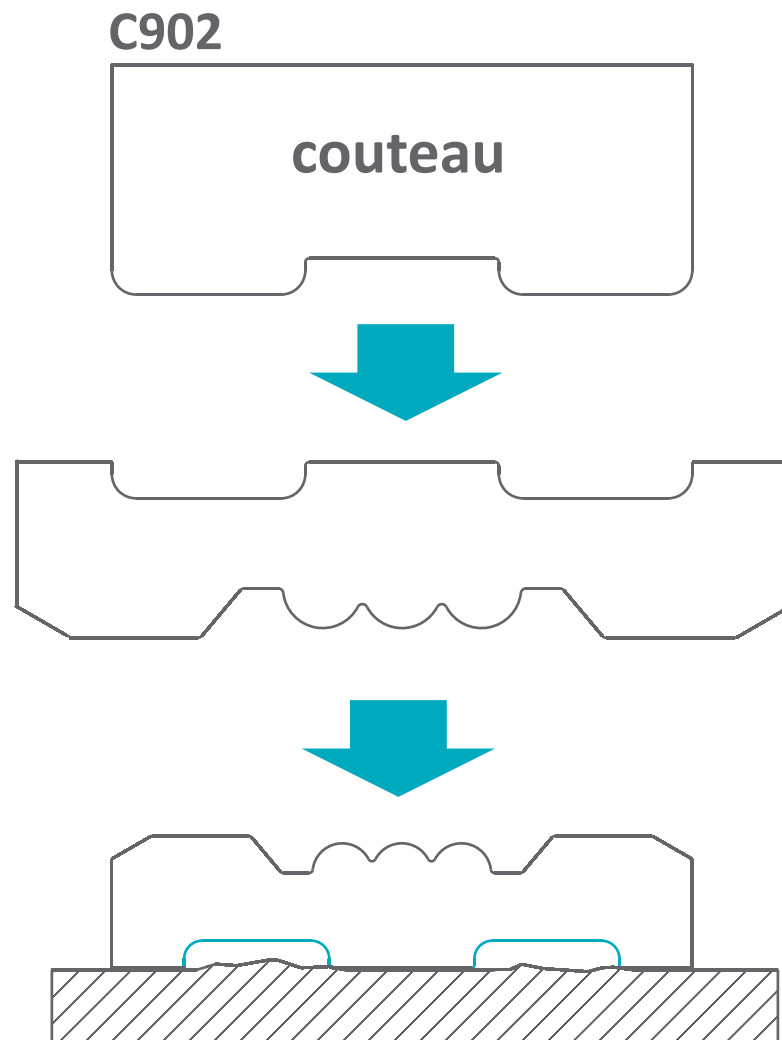

# Cadrage

casing

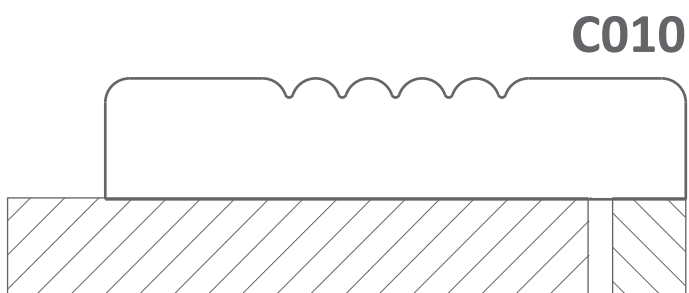
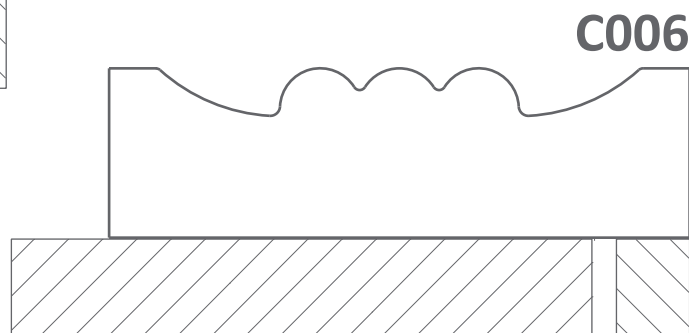
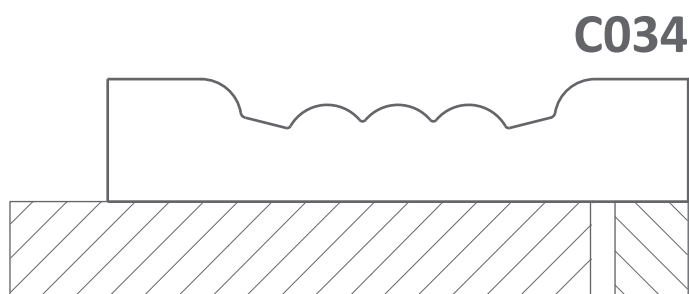
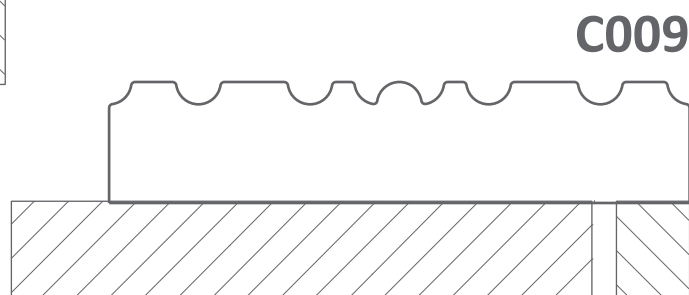
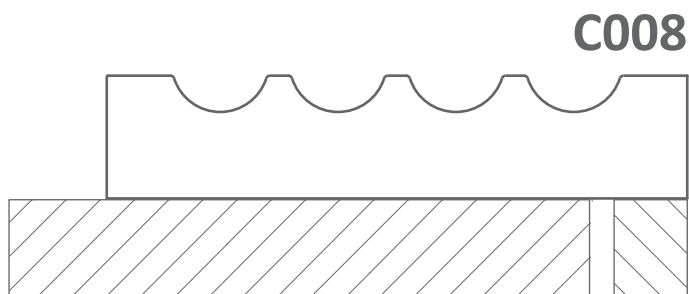
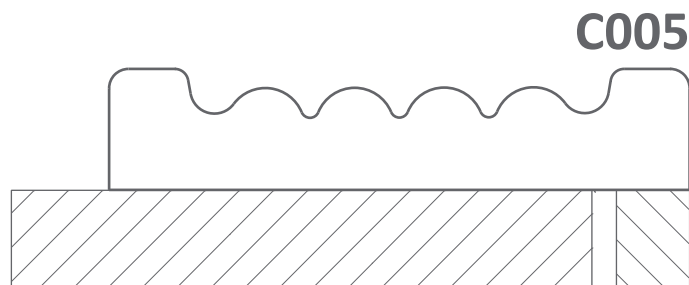

**C015**

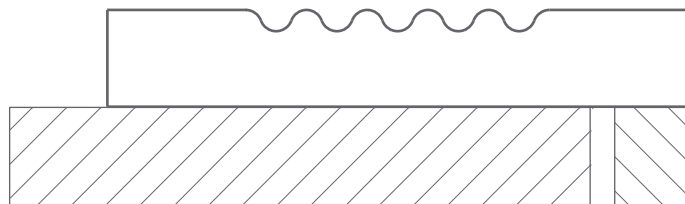

**C016**

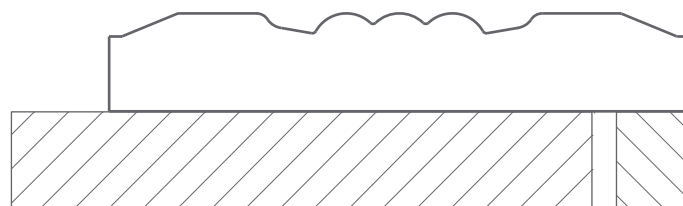

**C018**

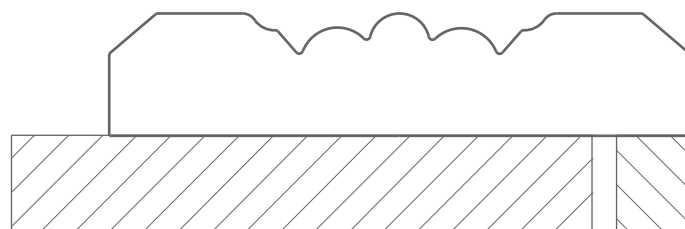

**C028**

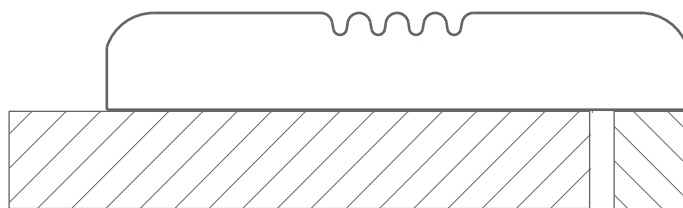

**C011**

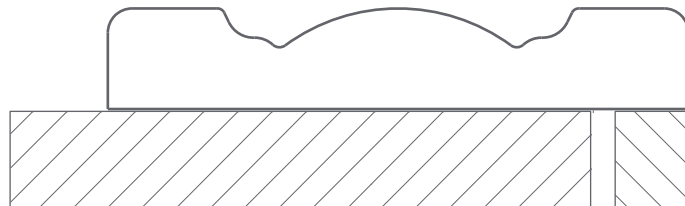

**C012**

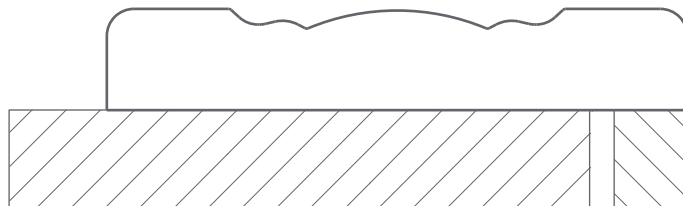

# Cadrage

casing

**C014**

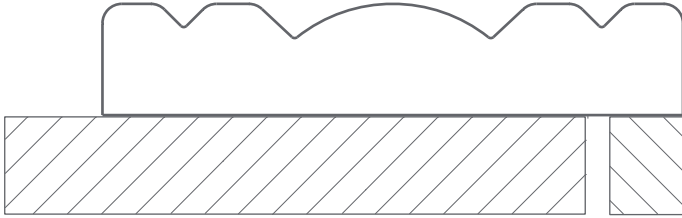

**C026**

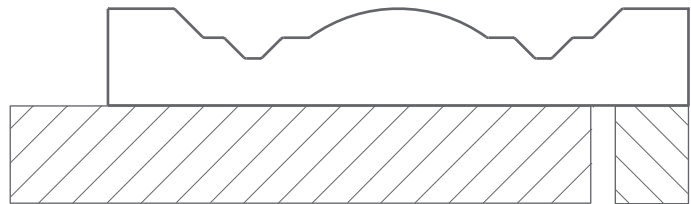

**C027**

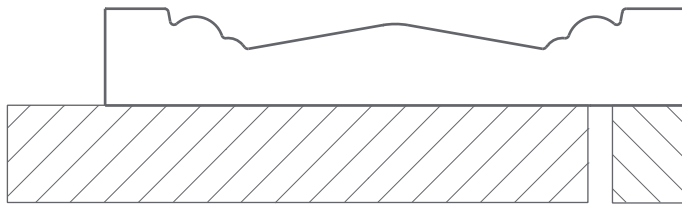

**C033**

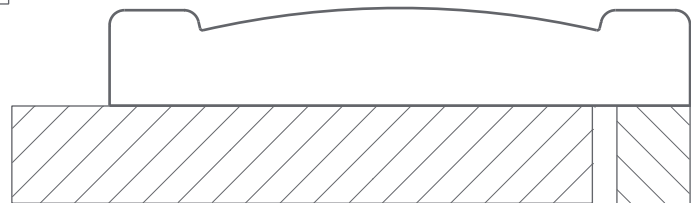

**C002**

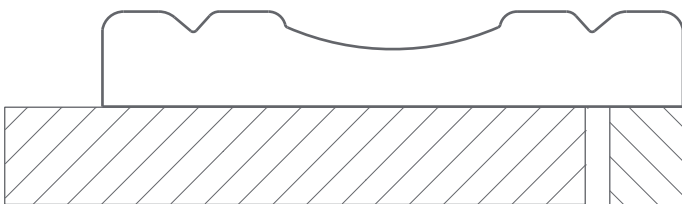

**C001**

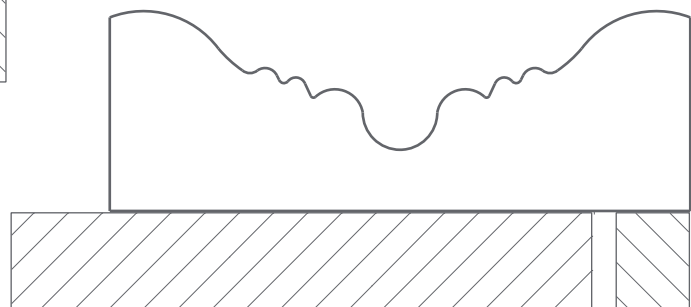

**C003**

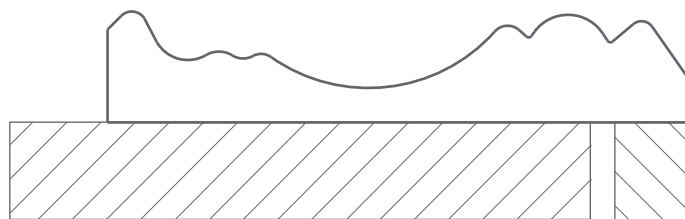

**C004**

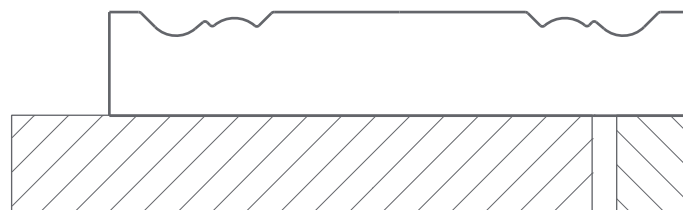

**C007**

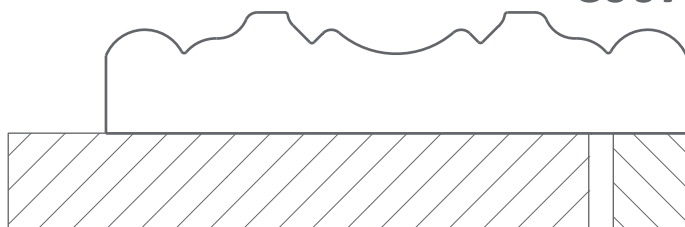

**C013**

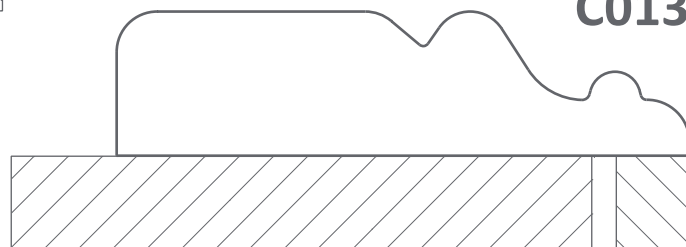

**C017**

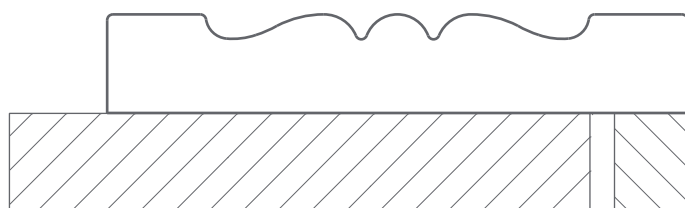

**C021**

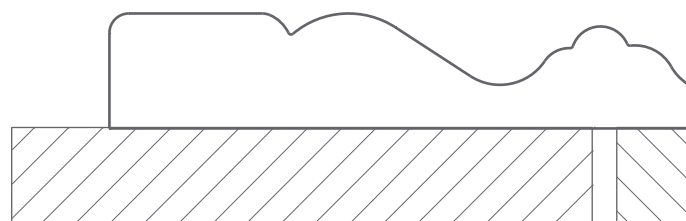

# Cadrage

casing

**C022**

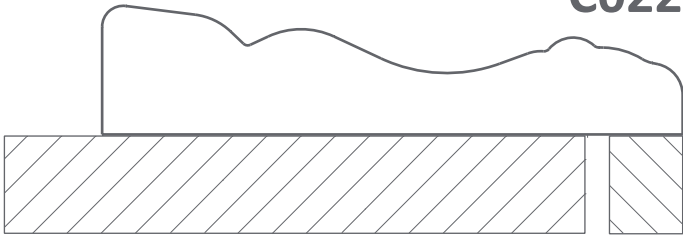

**C023**

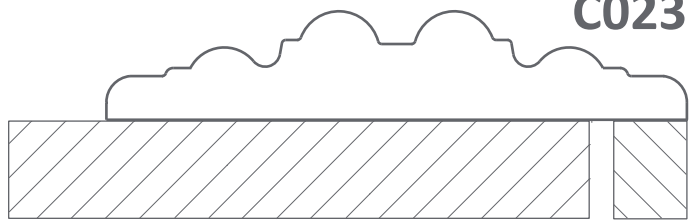

**C024**

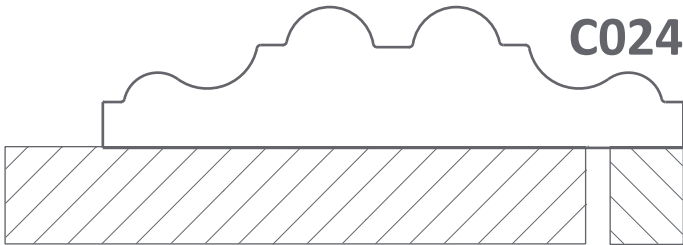

**C025**

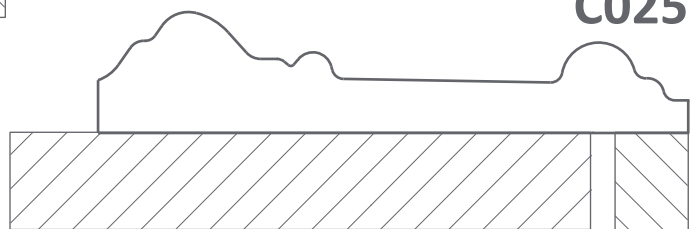

**C029**

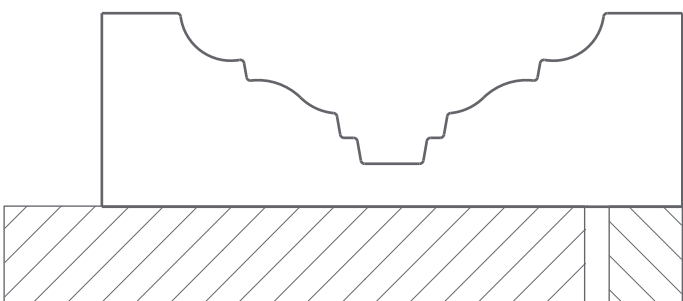

**C030**

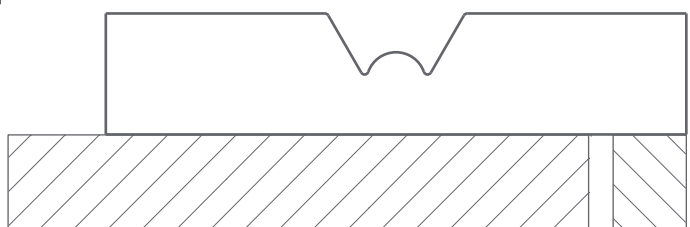

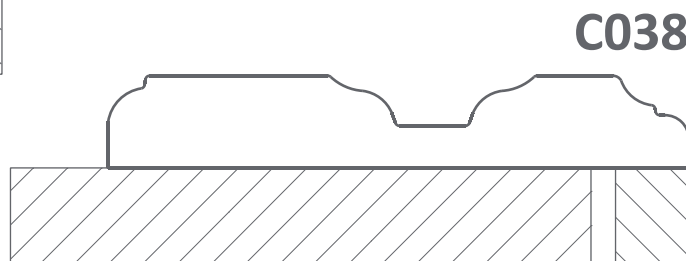
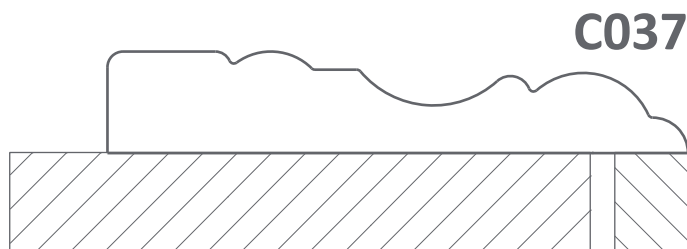
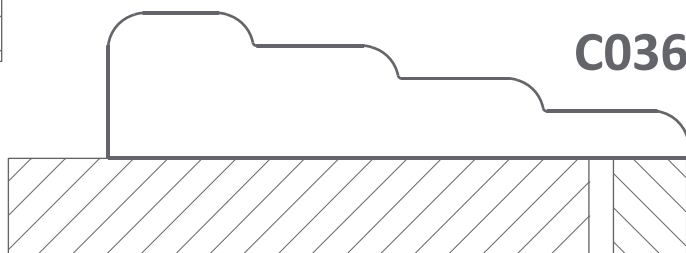
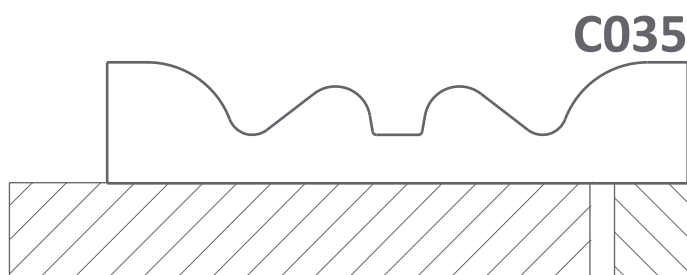
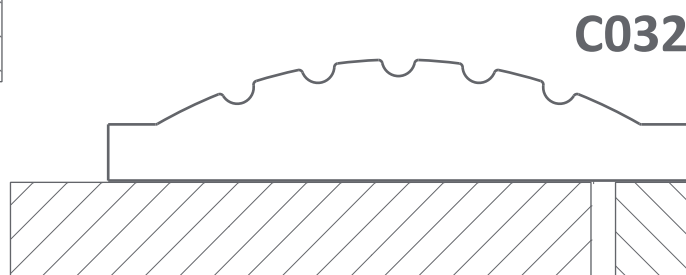
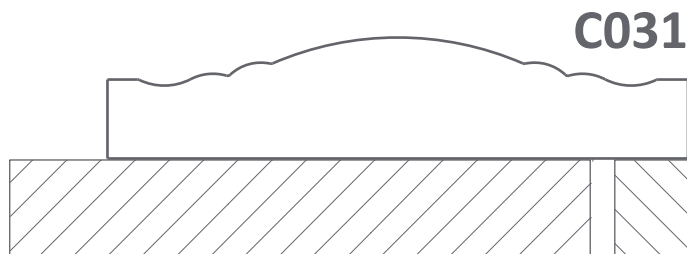

**C501**

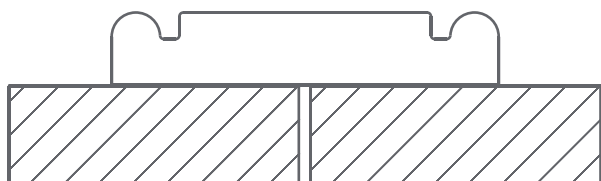

**C502**

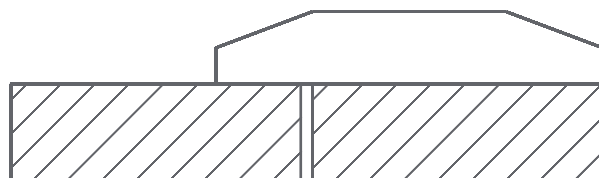

**C503**

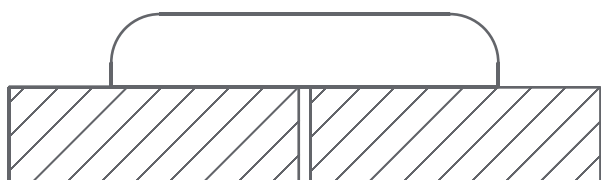

**C504**

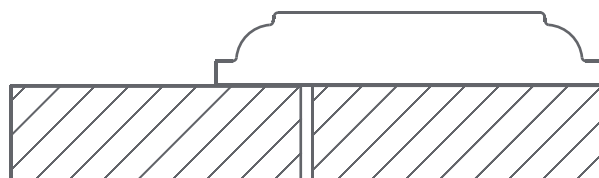

**C505**

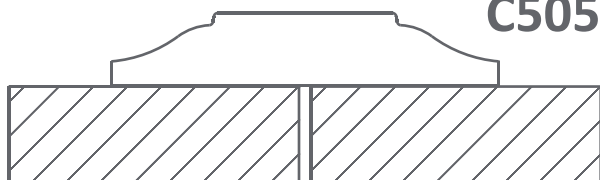

**C506**

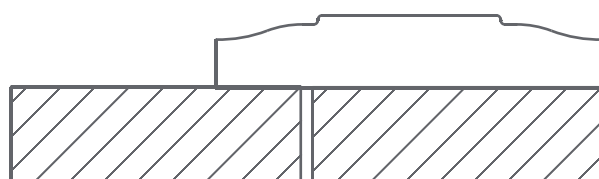



# Moulure de porte

door moulding

ÉCHELLE 1:1

# Moulure de haut de porte

door top moulding

**D001**

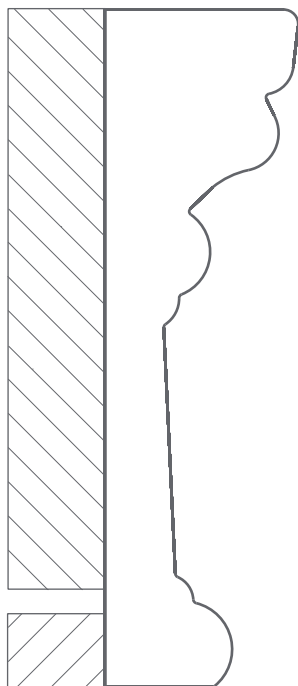

**D002**

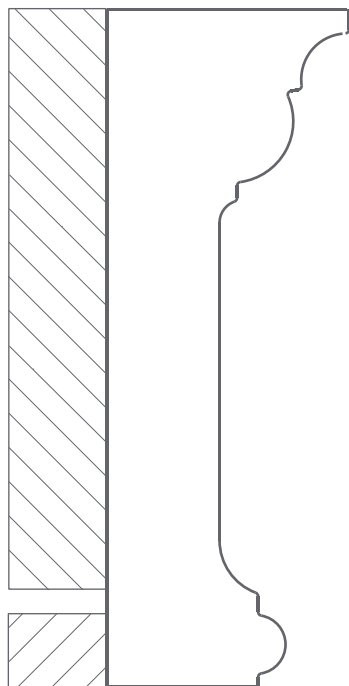

**D003**

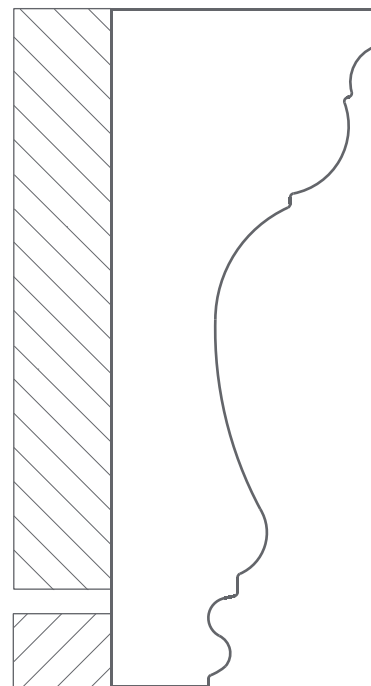

**D004**

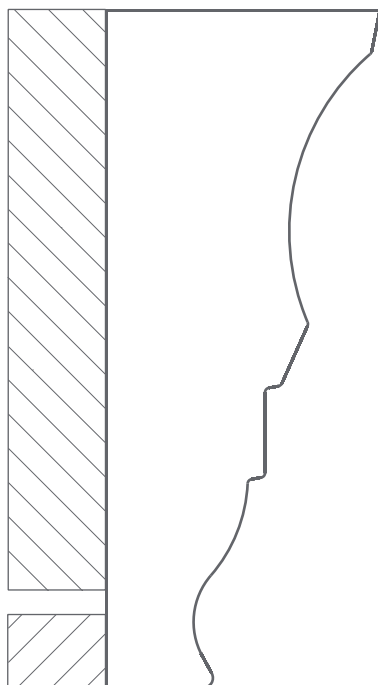

**D005**

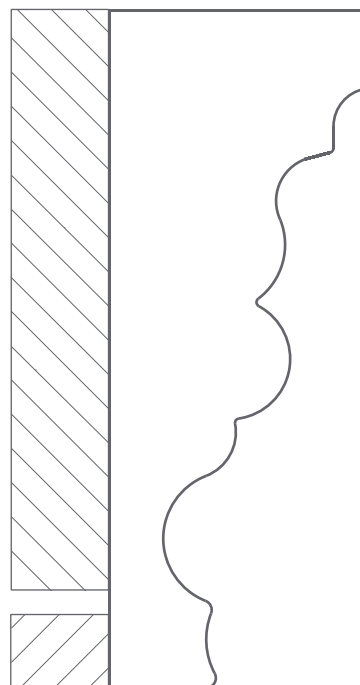

# Moulure de haut de porte

door top moulding

D006

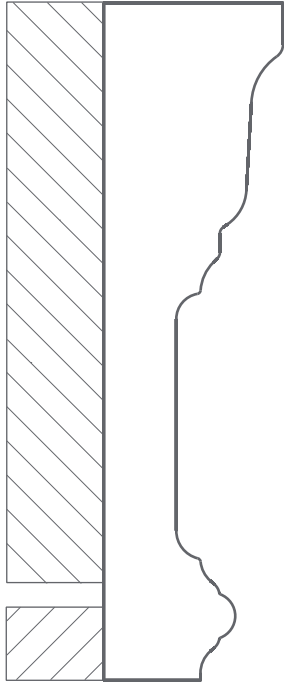

D007

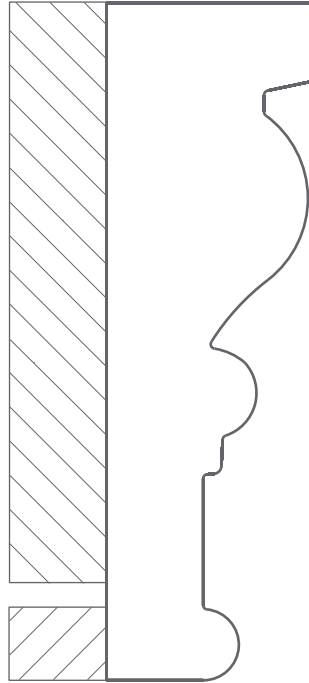

D008

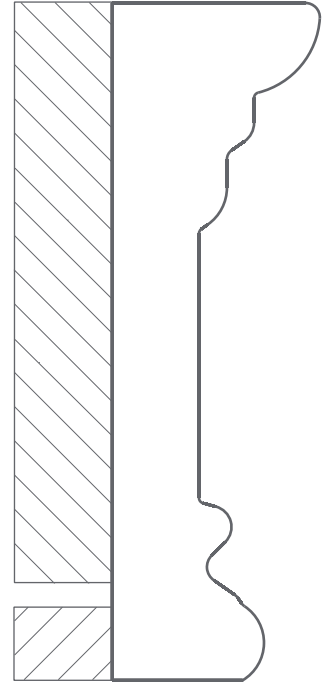

D009

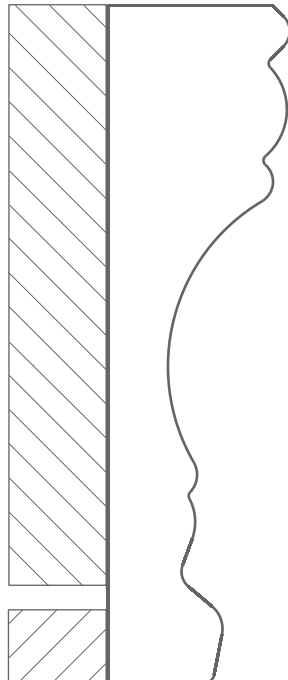

D010

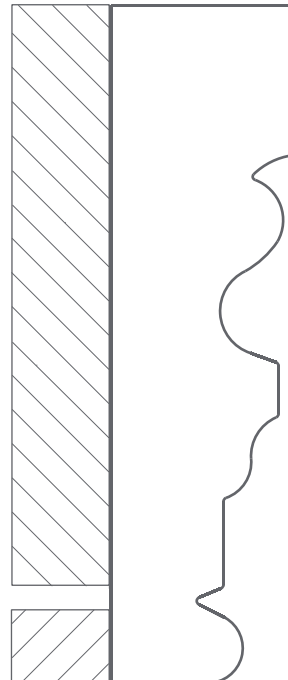

# Moulure de bas de porte

door bottom moulding

**D901**

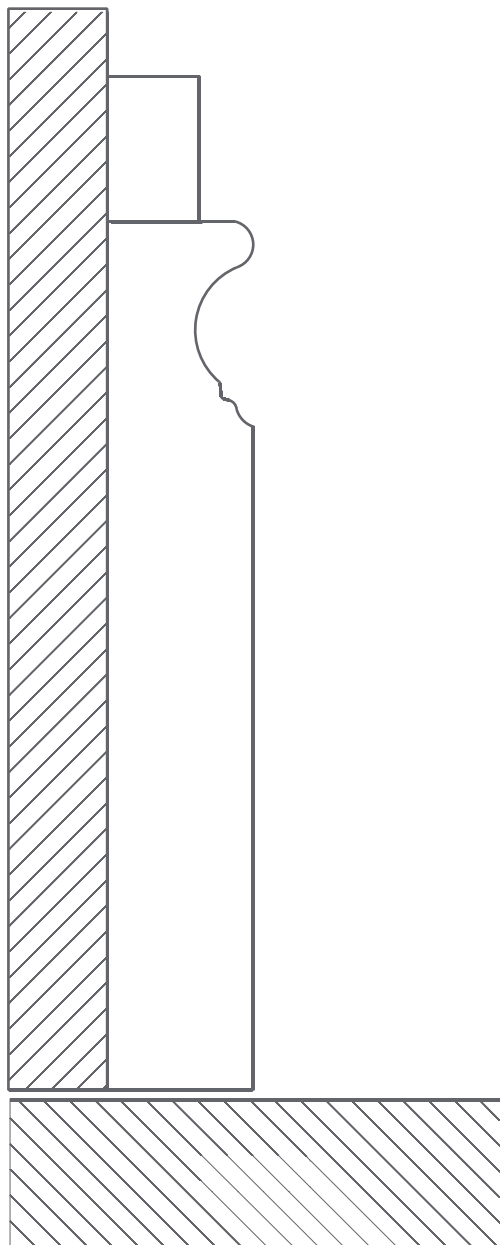

**D902**

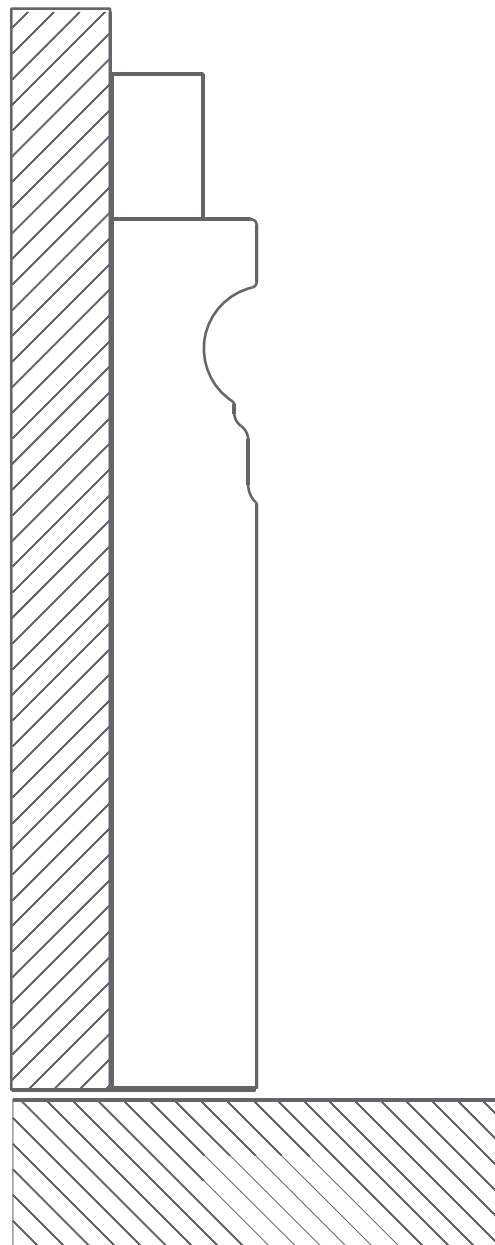

# Encadrement

pictures frame

ÉCHELLE 1:1

## couteau pour fabriquer le dos des encadrements

Knife to make back of pictures frame

E901

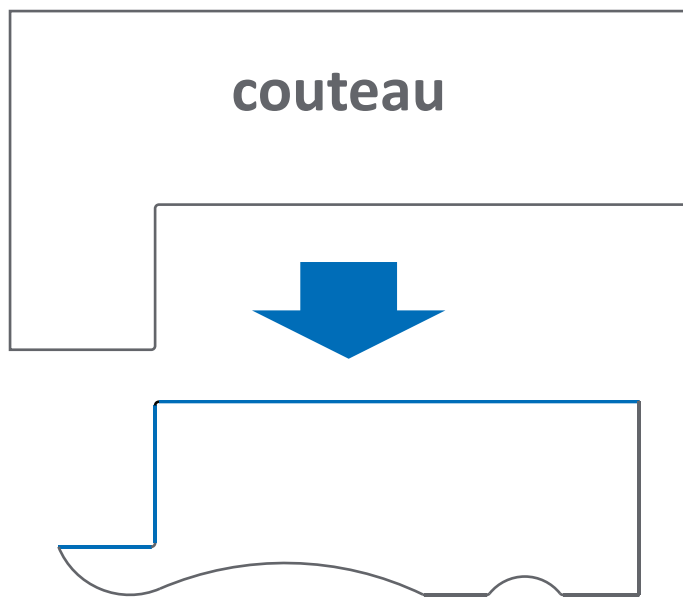

## couteau pour fabriquer le côté des encadrements

Knife to make sides of pictures frame

E902

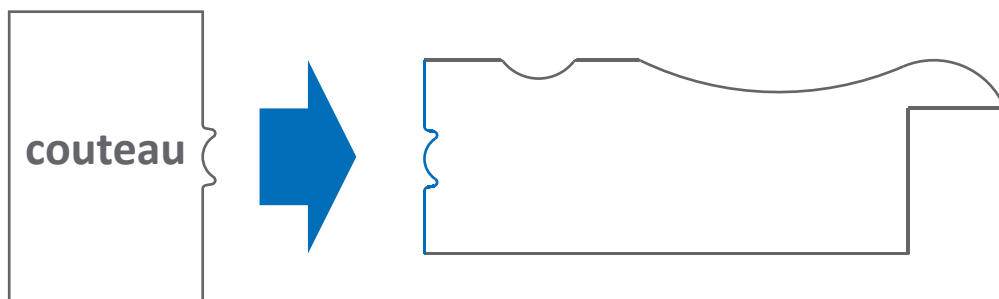

E903

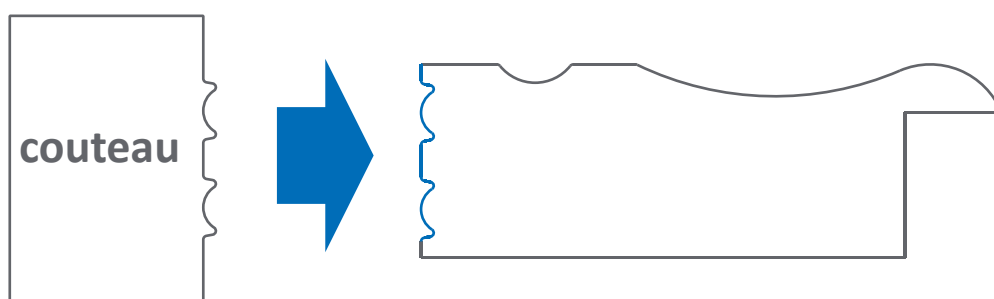

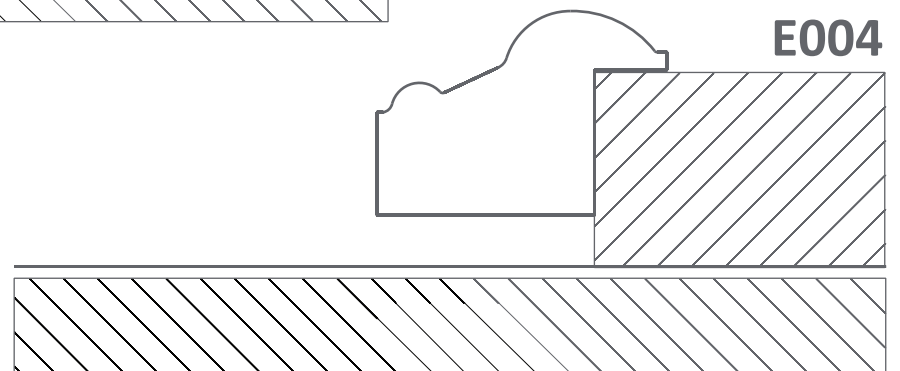
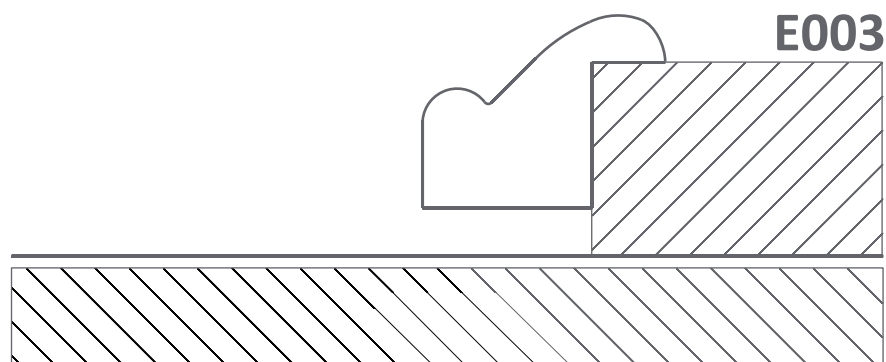
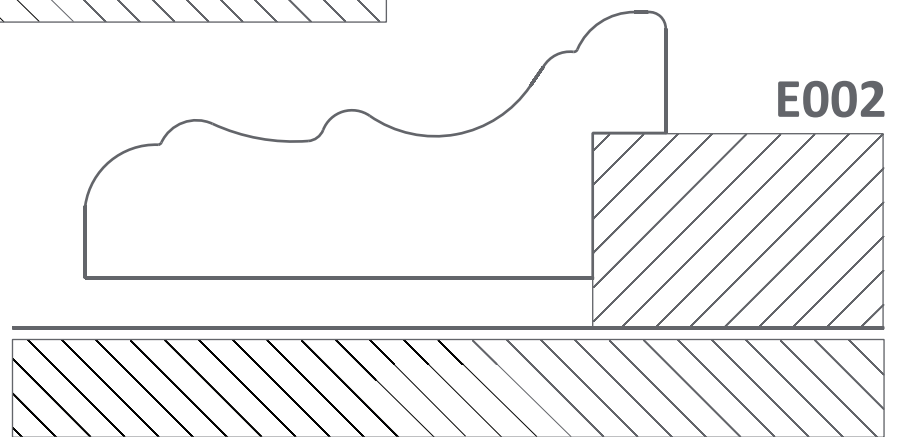
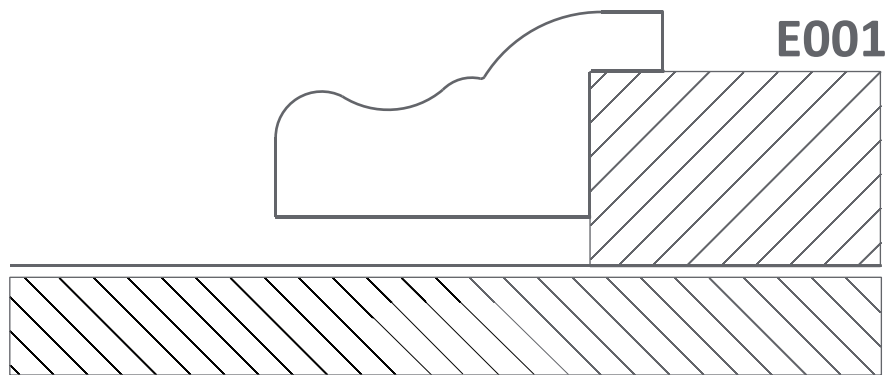

# Encadrement

pictures frame

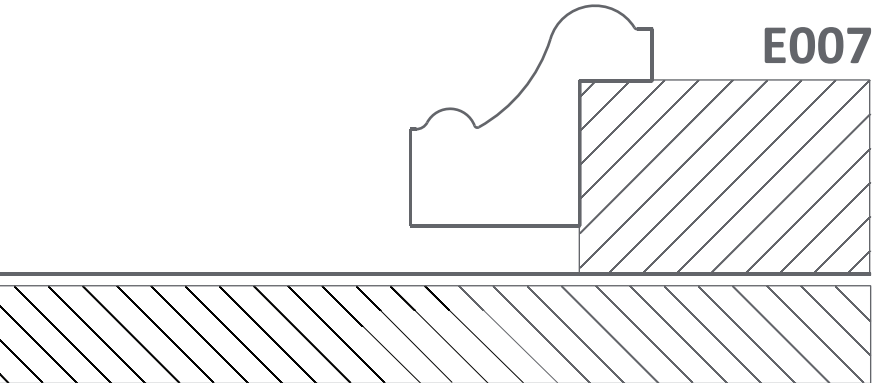
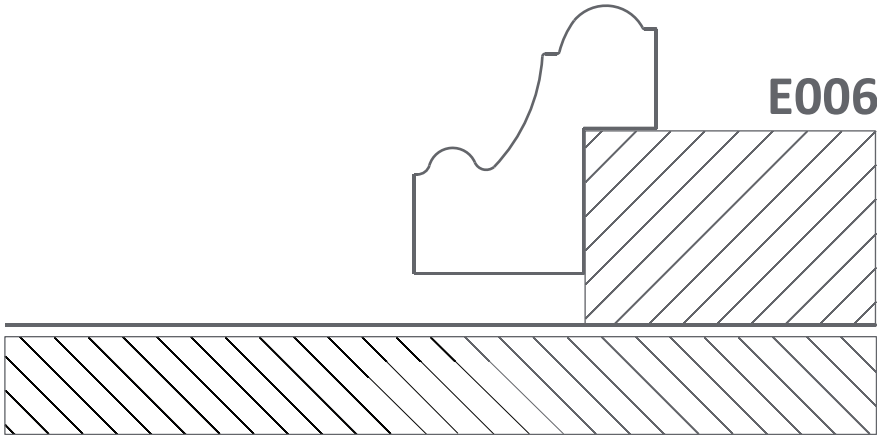
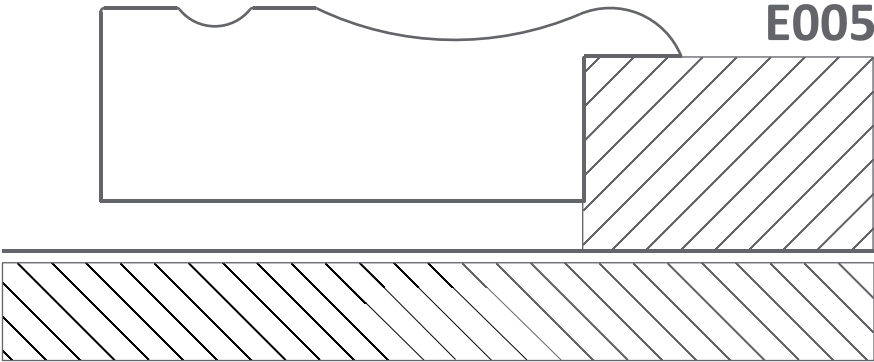



# Finition extérieure

outside finition

ÉCHELLE 1:1

# Finition extérieure

outside finition

## couteau pour fabriquer l'arrière des planches de finition extérieure

Knife to make the back of boards outside finition

F901

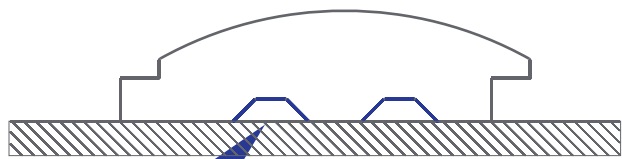
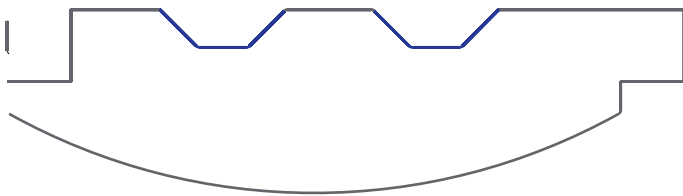
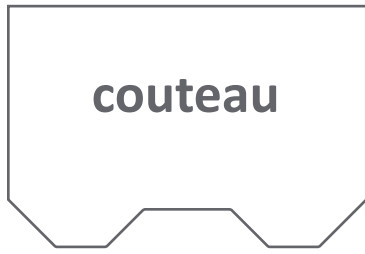

F902

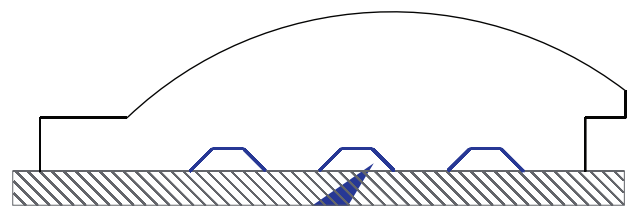
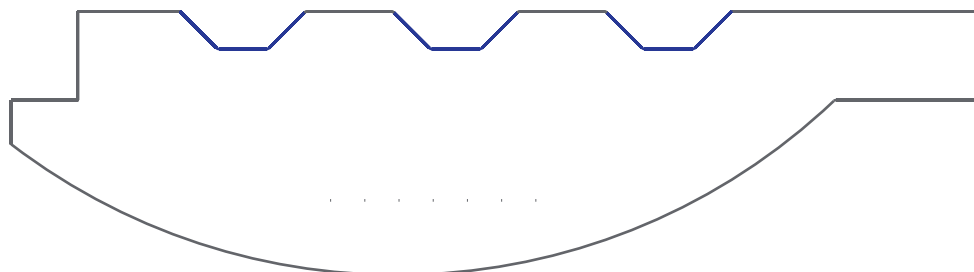
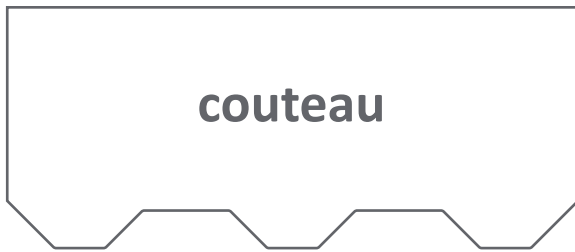

air

F001

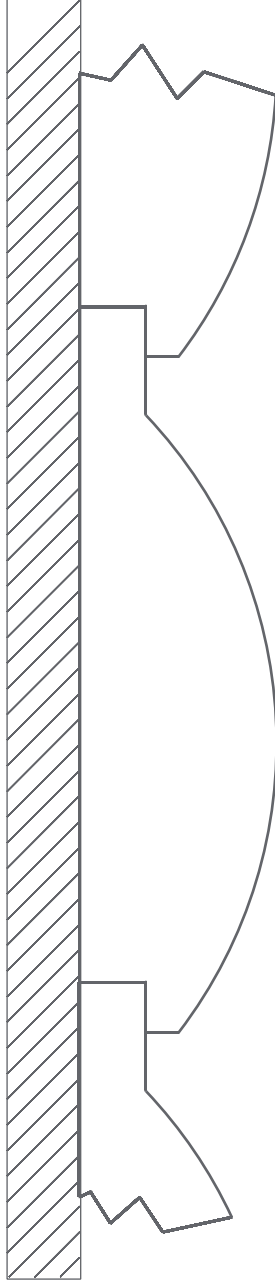

F002

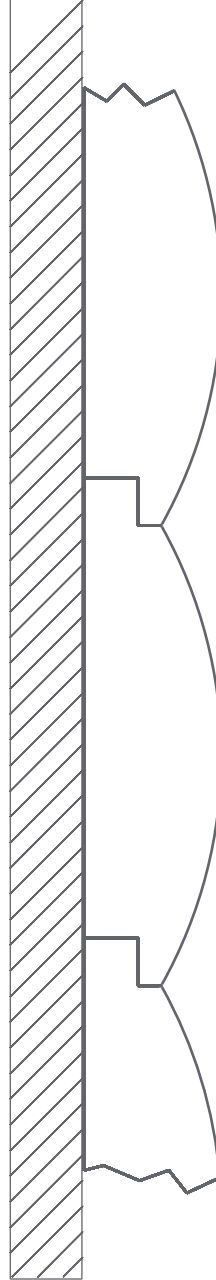

F003

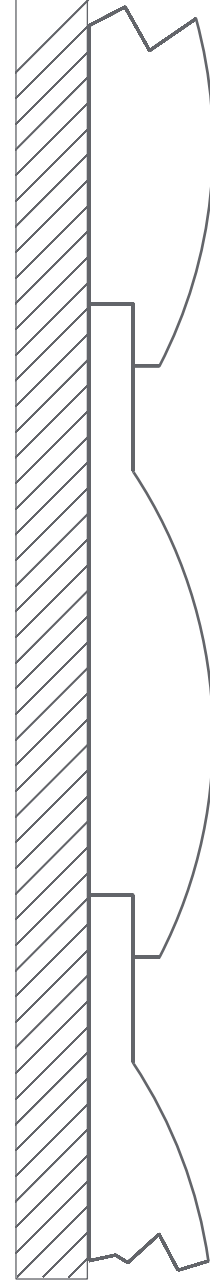

# Finition extérieure

outside finition

**F004**

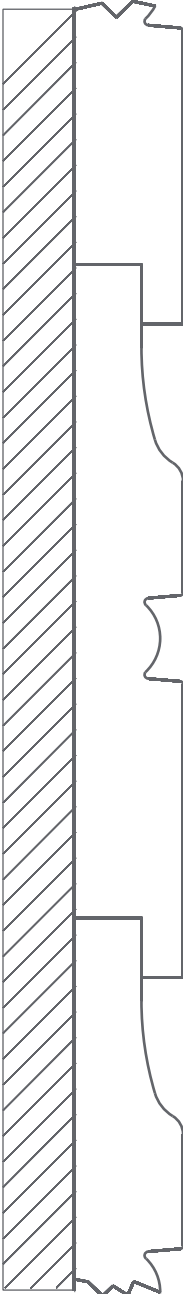

**F005**

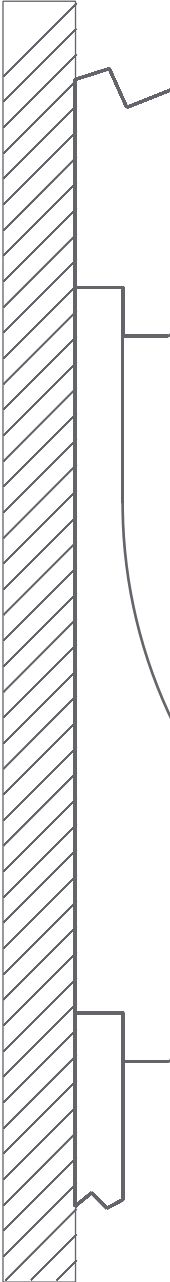

**F006**

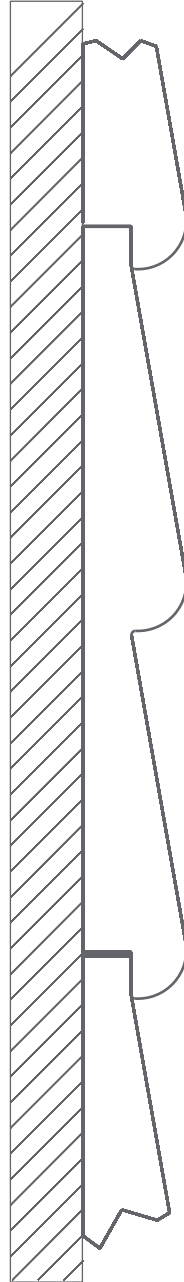

# Moulure couronnée

(O'Gees)  
crown moulding

ÉCHELLE 1:1

# Moulure couronnée

(O'Gees)

crown moulding

## couteaux pour fabriquer l'angle du O'Gee

Knives to make angles of crown

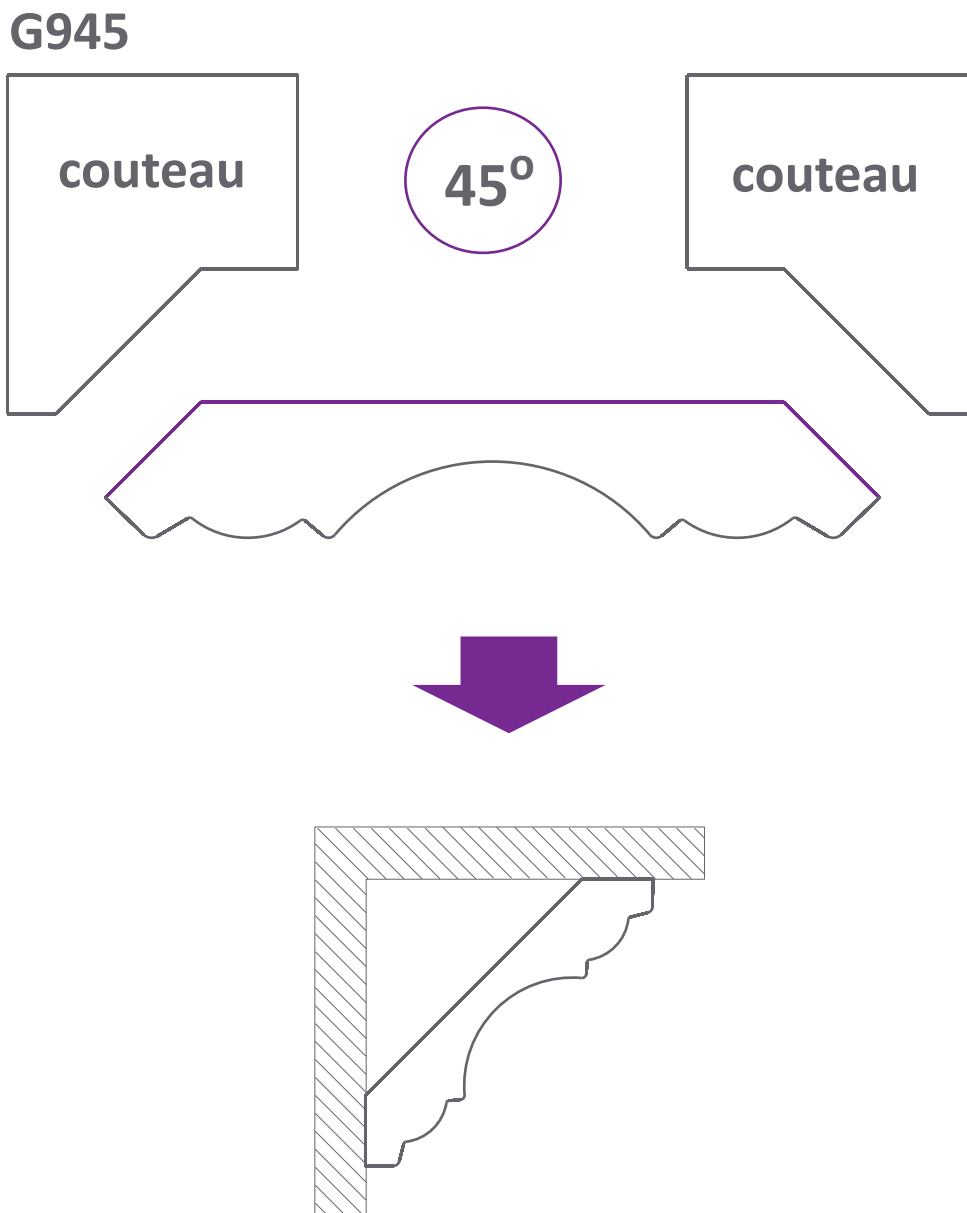

## couteaux pour fabriquer l'angle du O'Gee

Knives to make angles of crown

G952

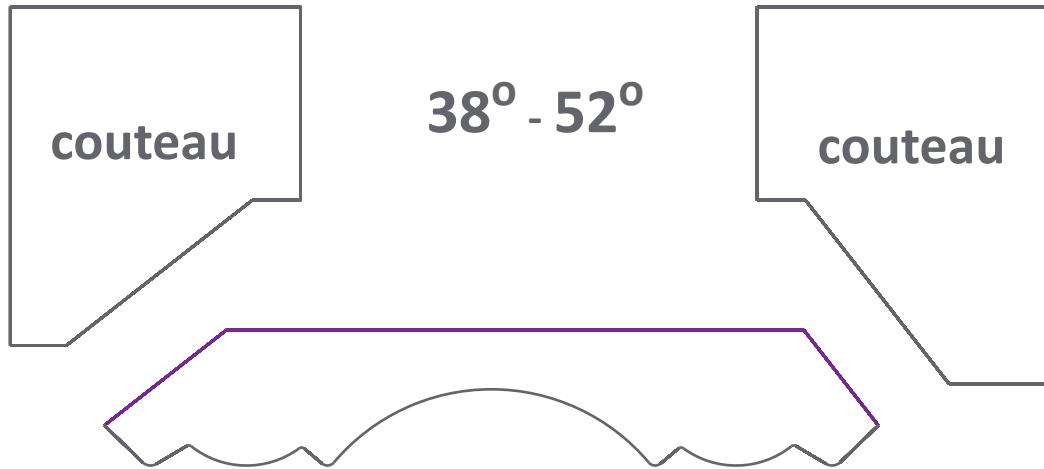

**solution A**

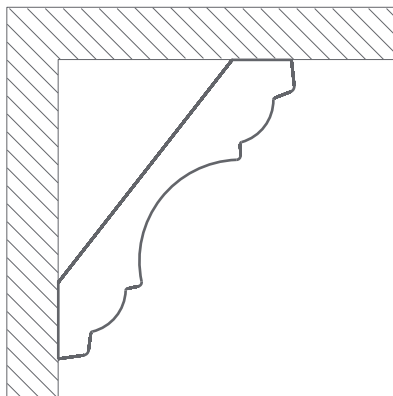

**solution B**

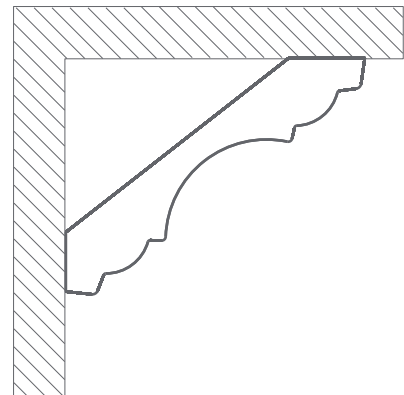

# Moulure couronnée

(O'Gees)

crown moulding

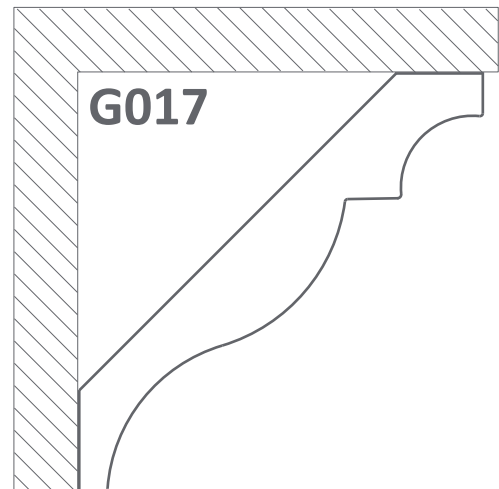
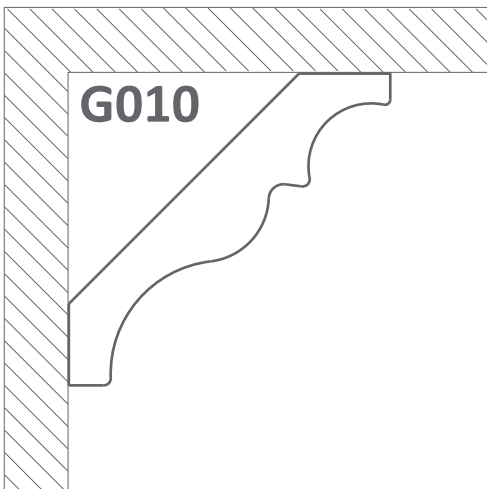
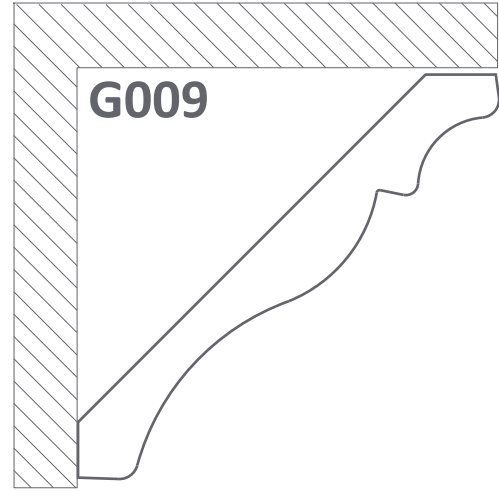
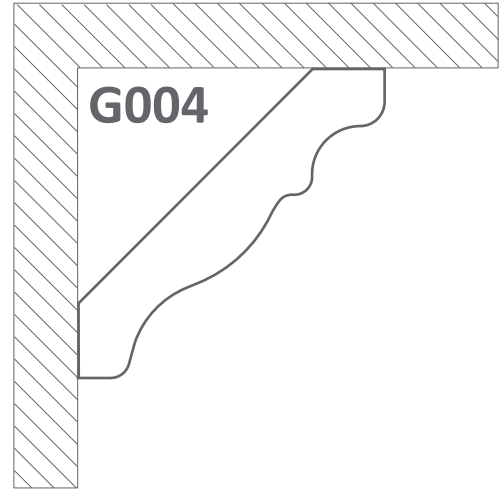
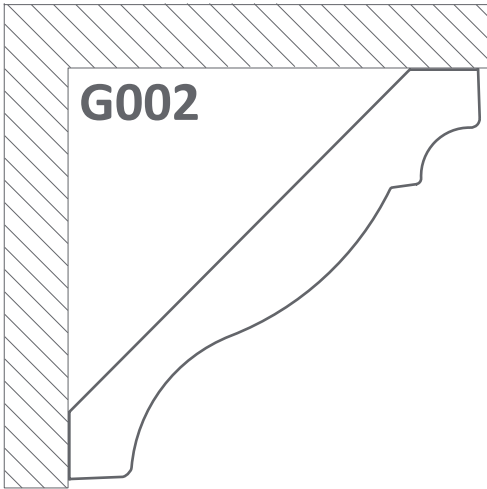



# Moulure couronnée

(O'Gees)  
crown moulding

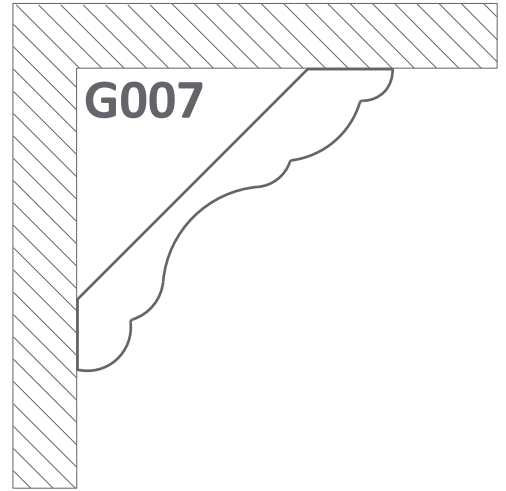

# Moulure couronnée

(O'Gees)

crown moulding

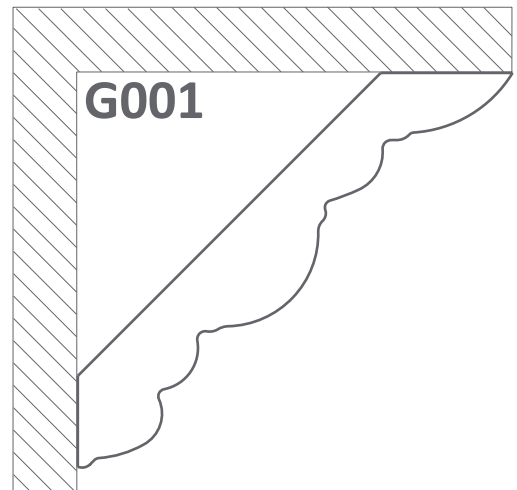
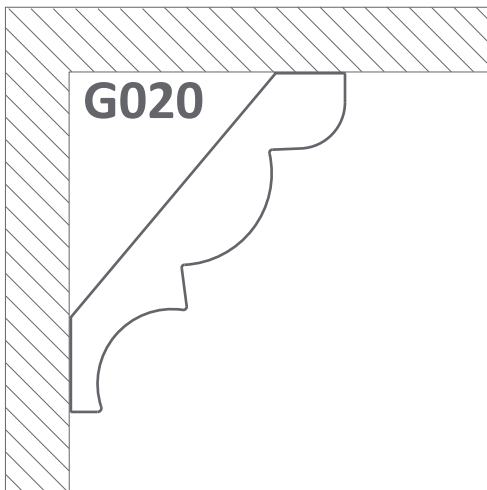
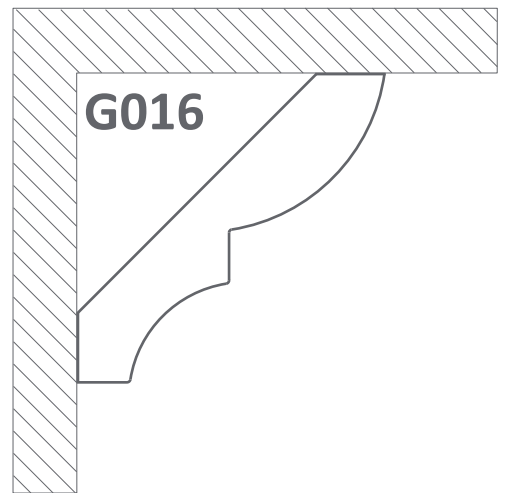
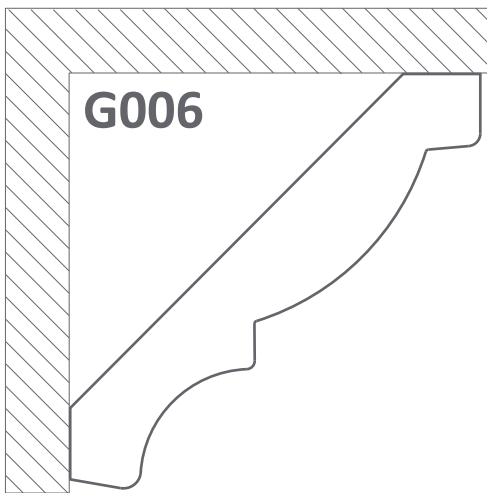
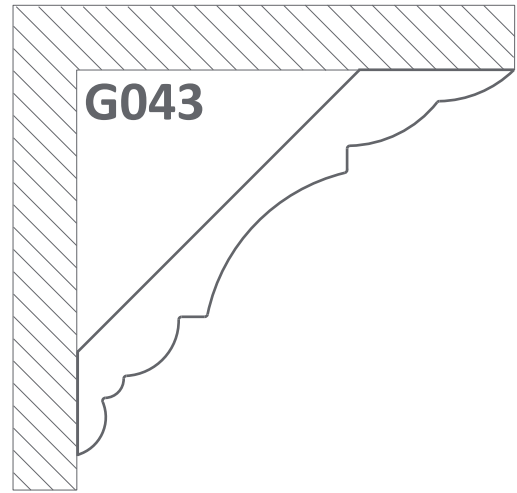

# Moulure couronnée

(O'Gees)  
crown moulding

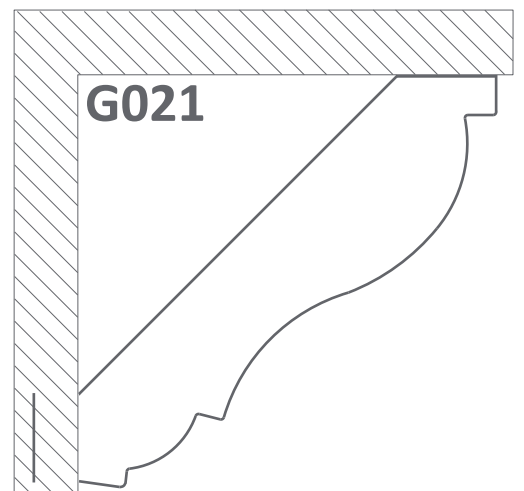
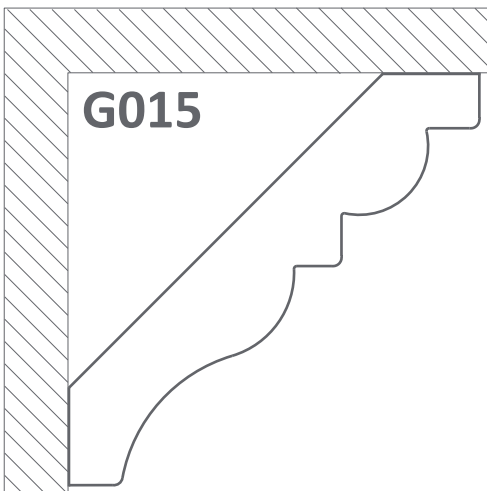
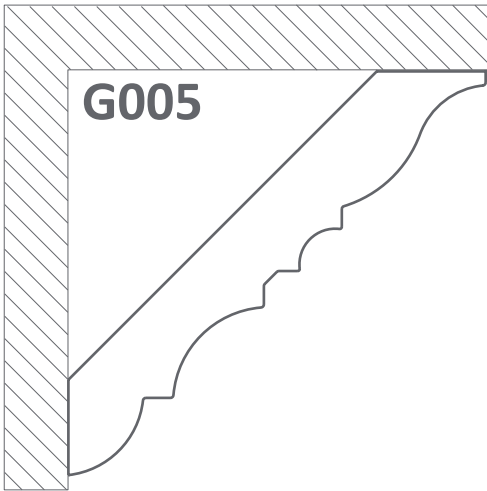

# Moulure couronnée

(O'Gees)

crown moulding

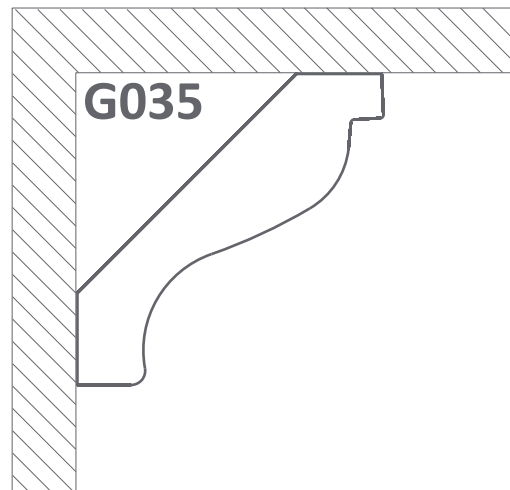
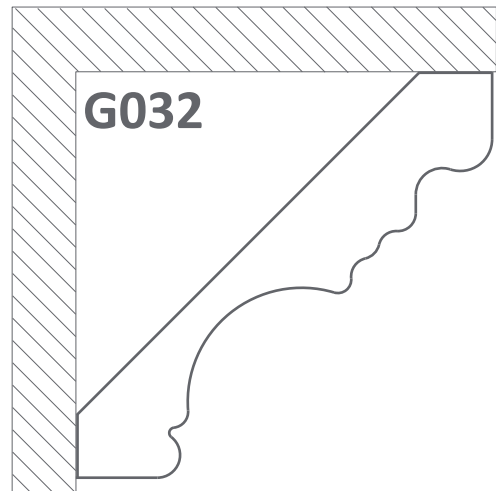
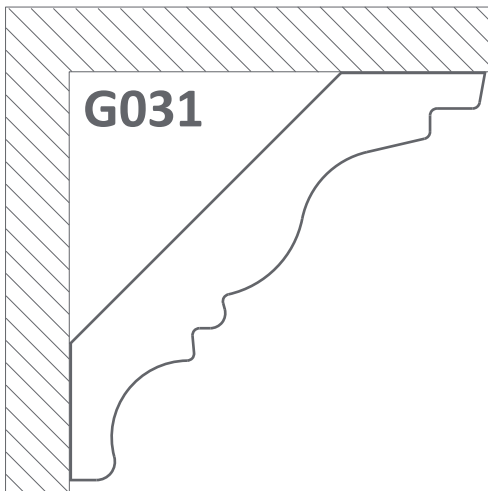
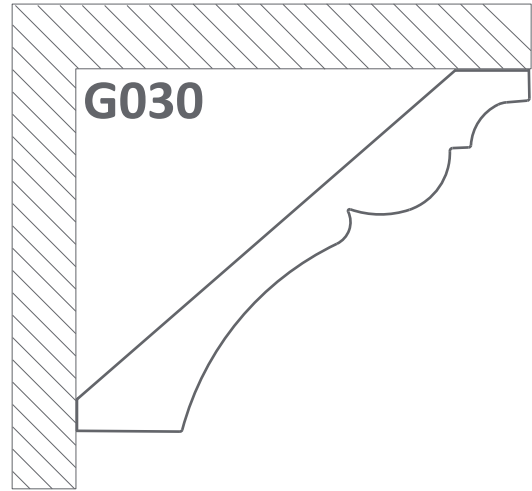
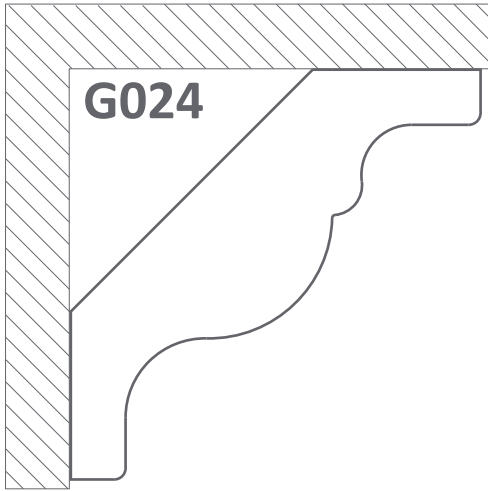

# Moulure couronnée

(O'Gees)  
crown moulding

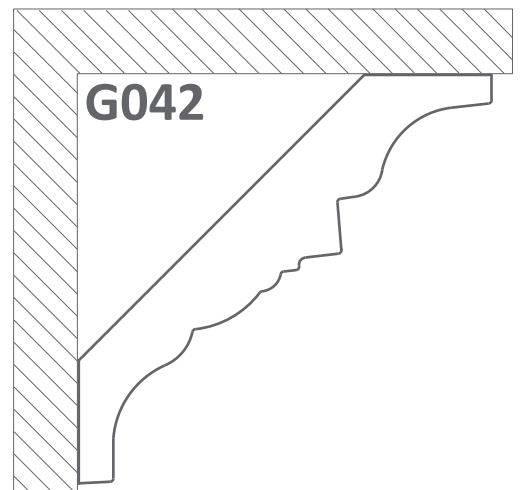
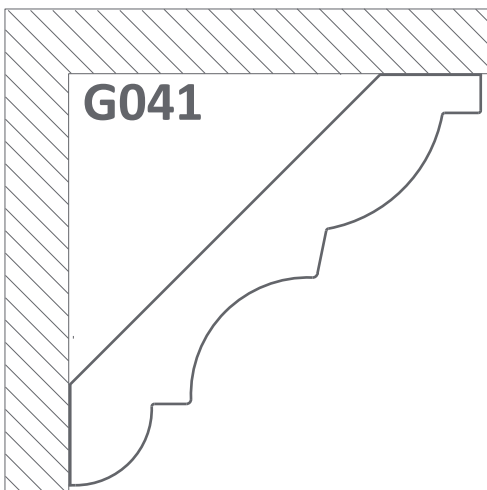
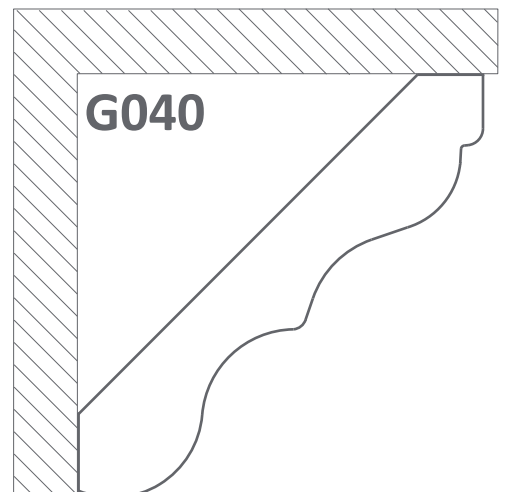
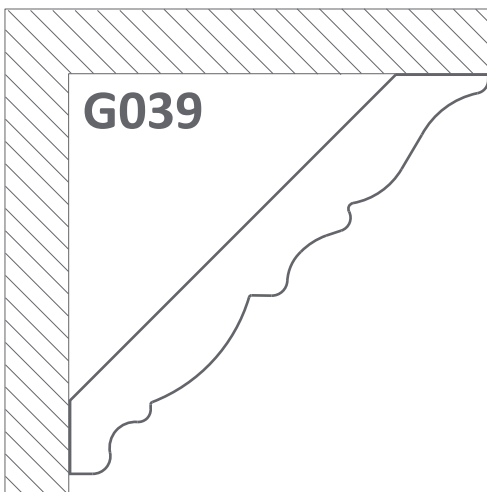

# Moulure couronnée

(O'Gees)

crown moulding

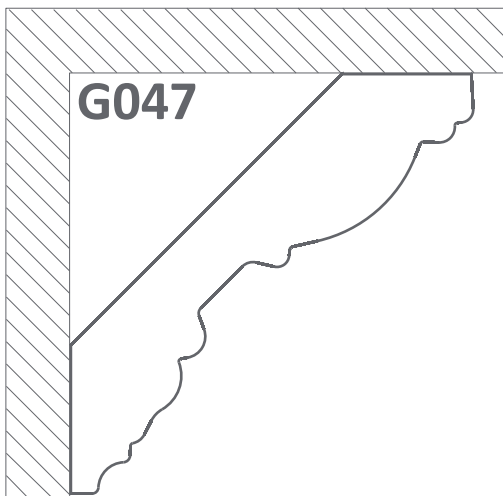
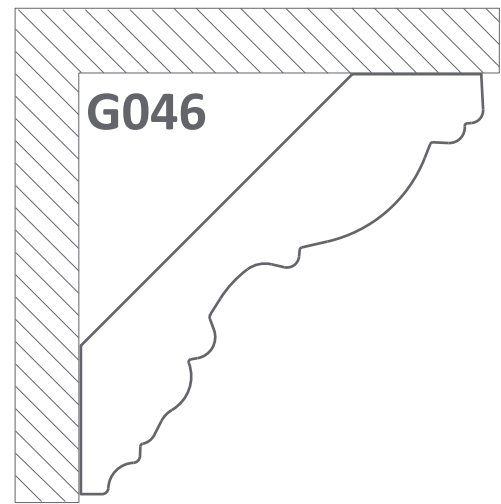

# Moulure couronnée

(O'Gees)  
crown moulding

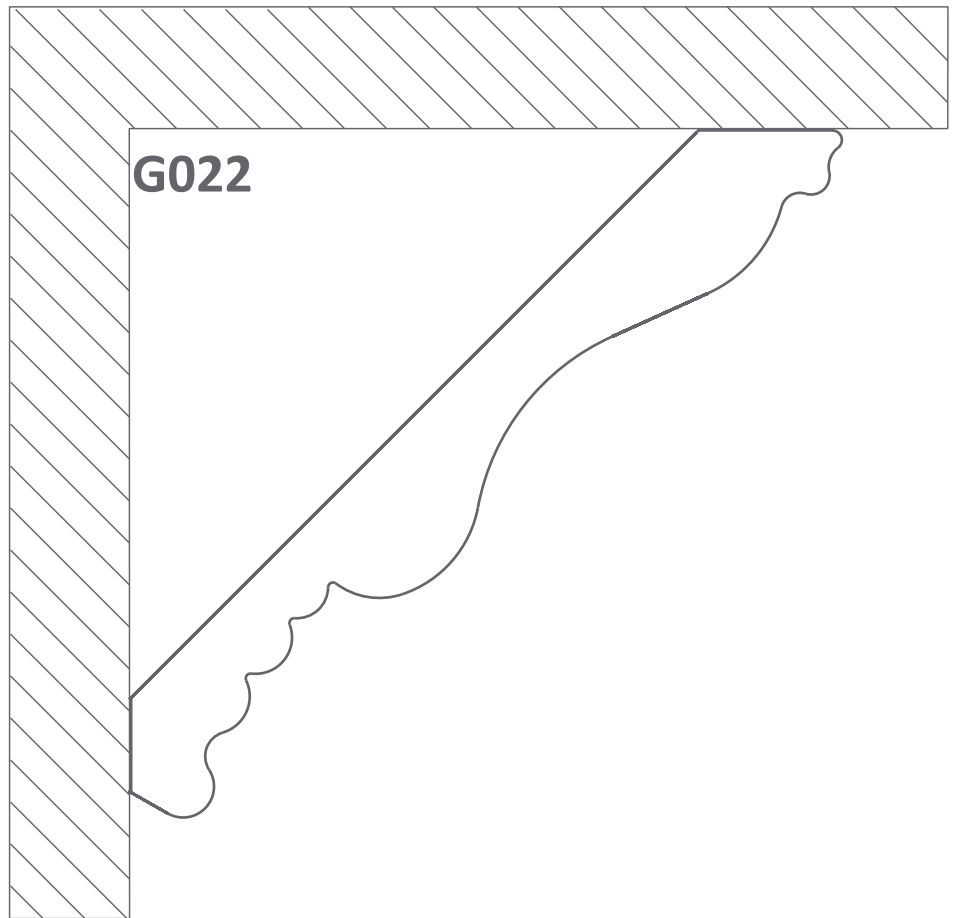
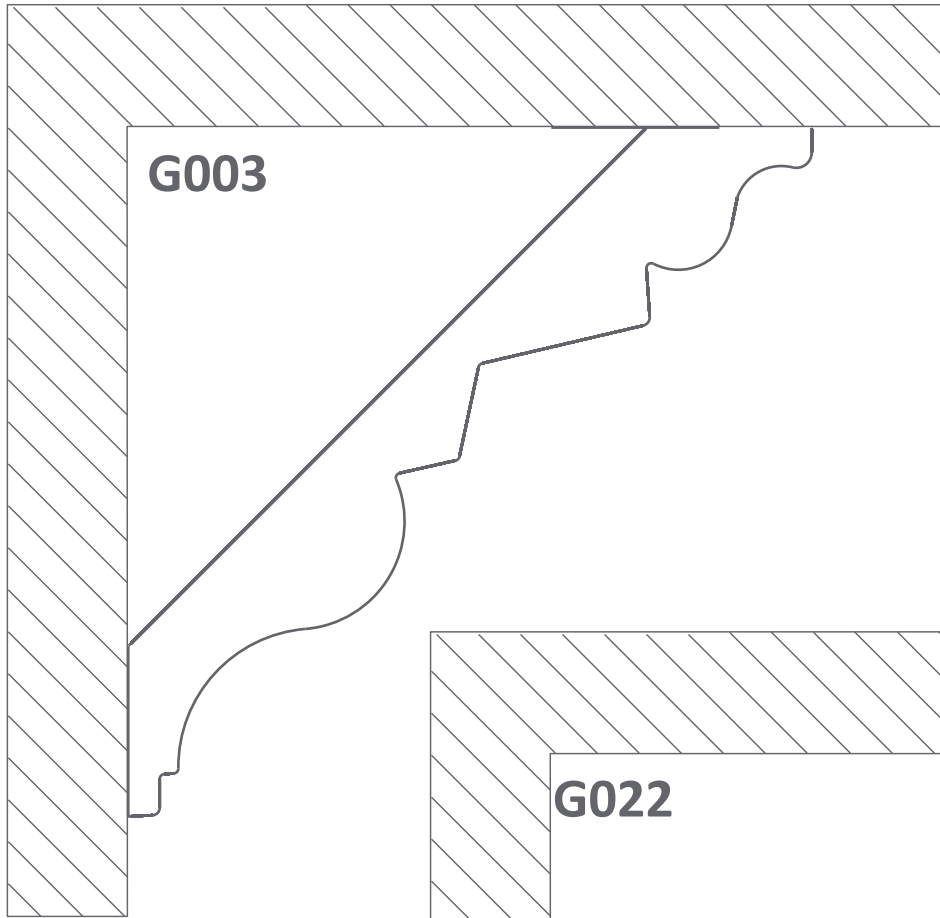

# Moulure couronnée

(O'Gees)

crown moulding

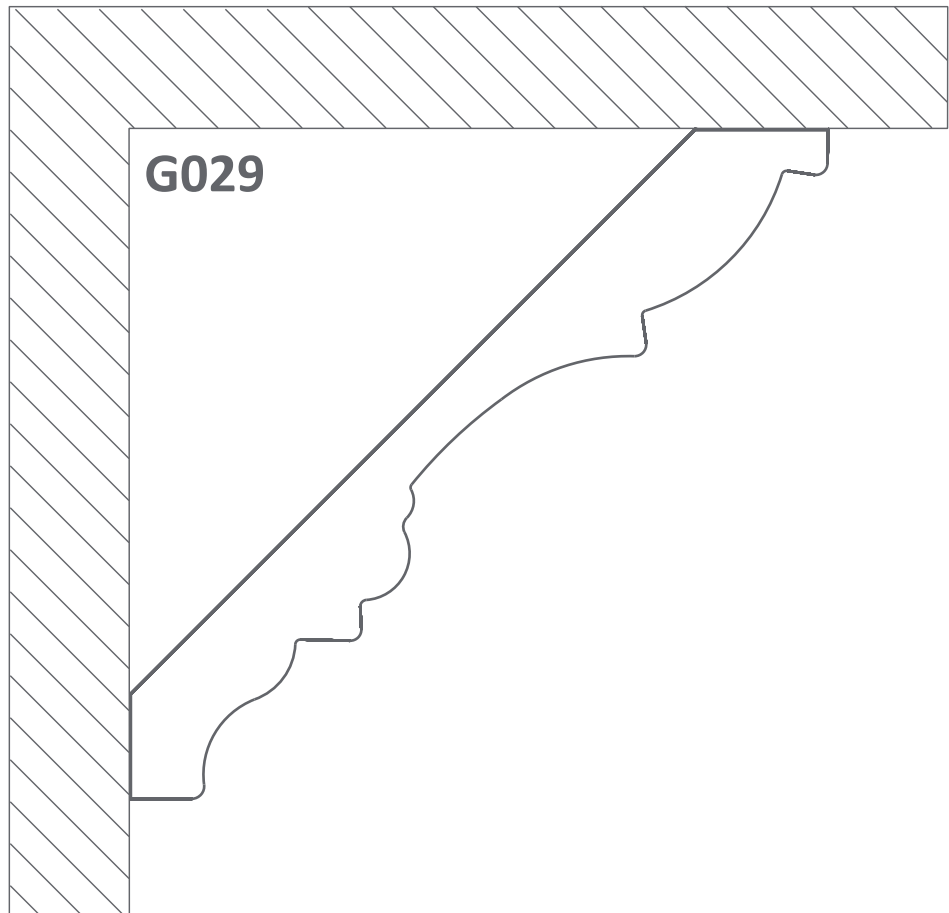
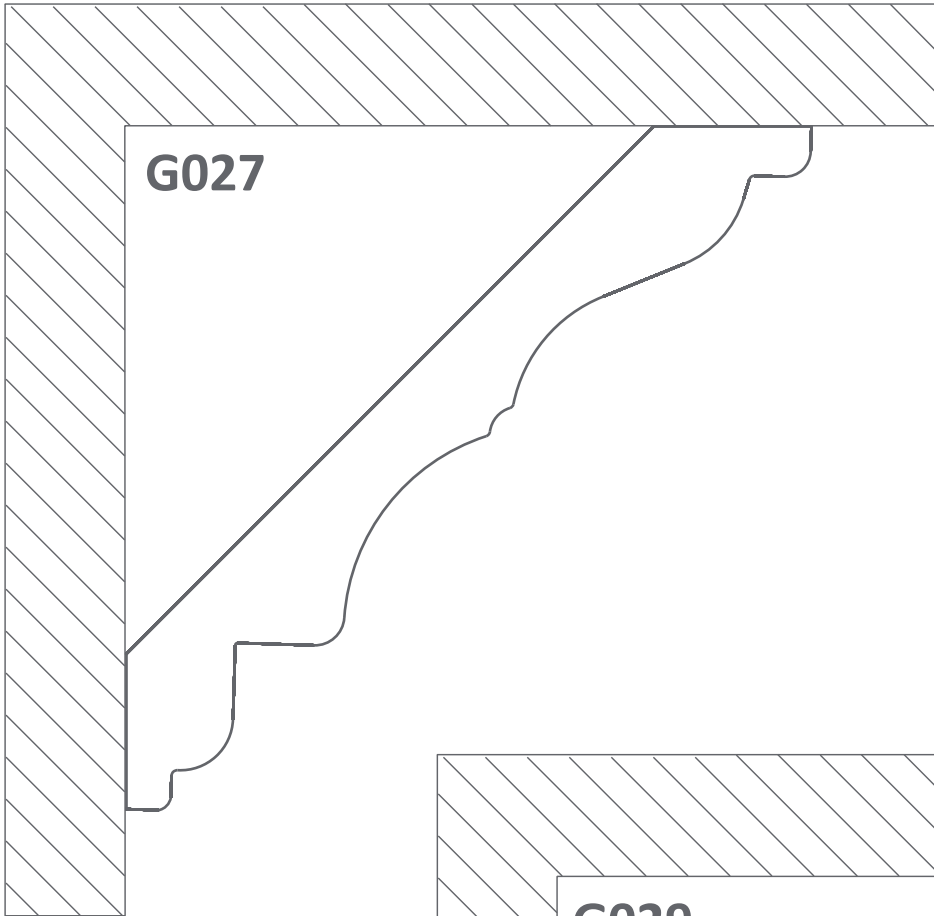



# Moulure couronnée

(O'Gees)  
crown moulding

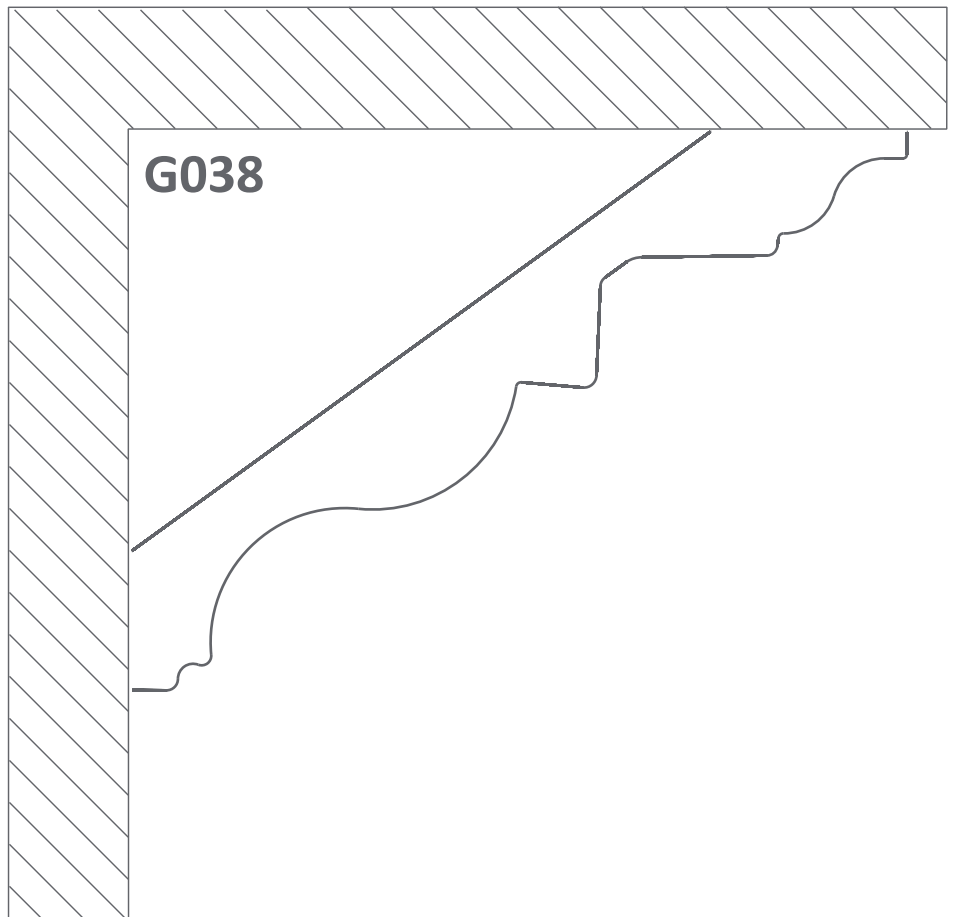
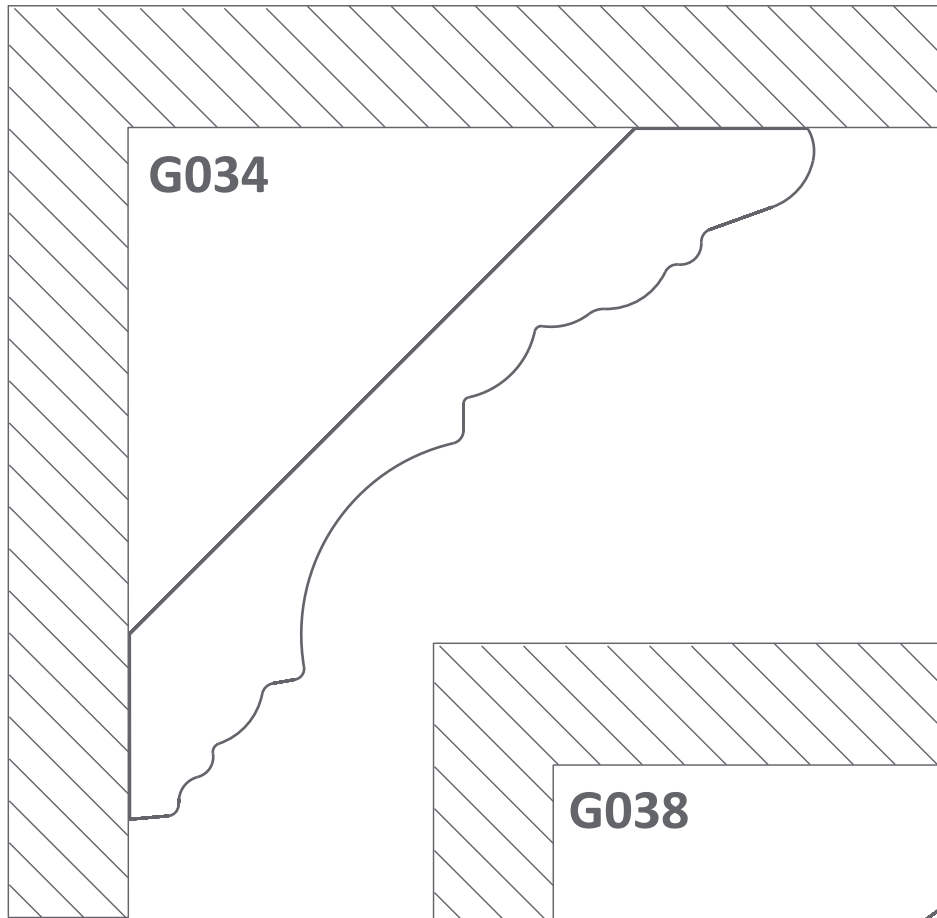

# Moulure couronnée

(O'Gees)

crown moulding

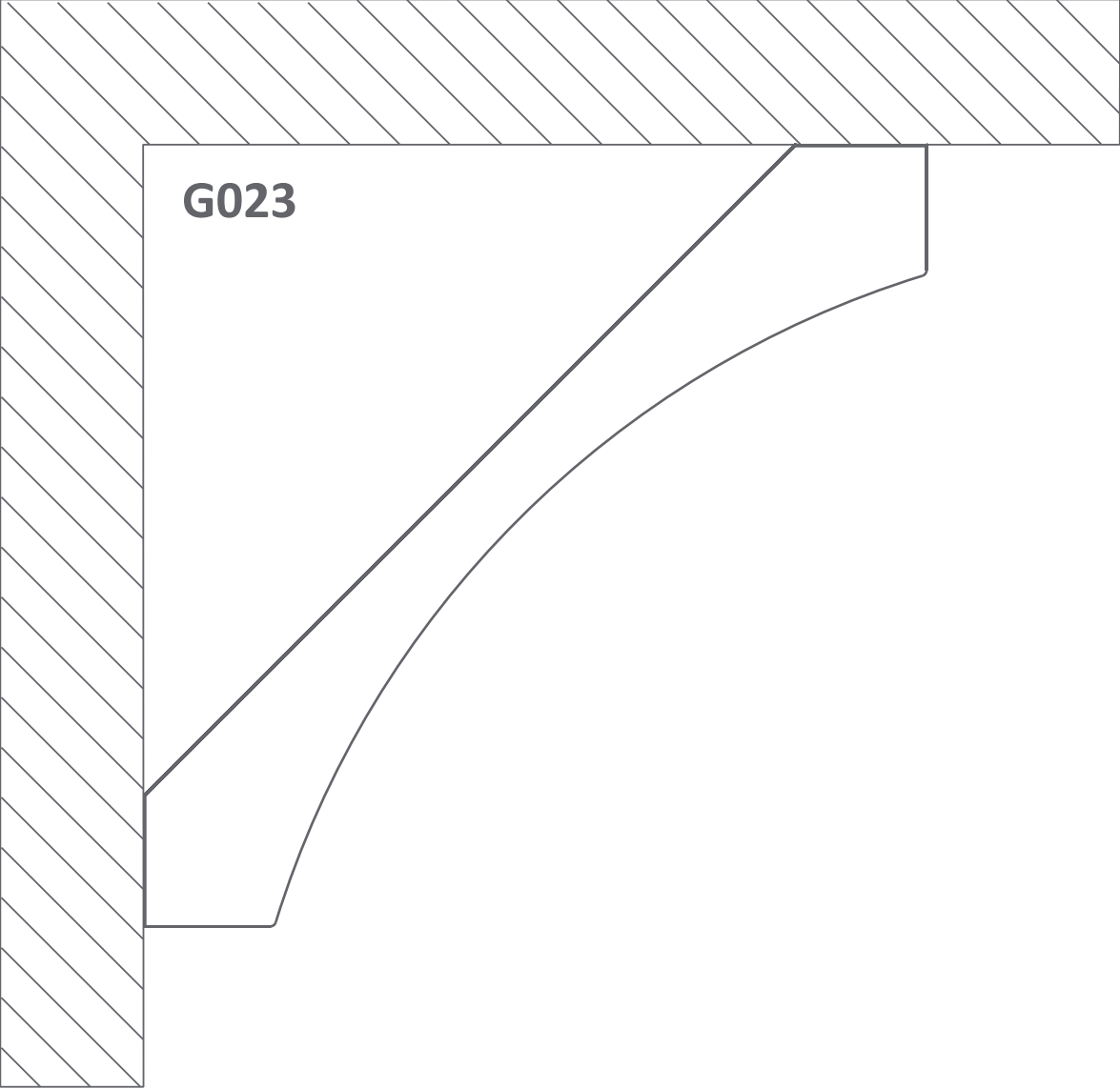

# Cimaise

## chair rail

ÉCHELLE 1:1

**H002**

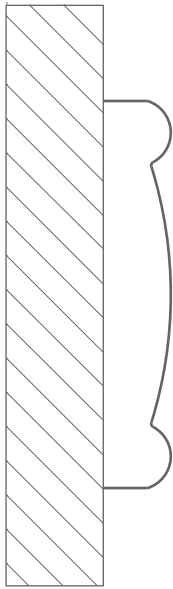

**H018**

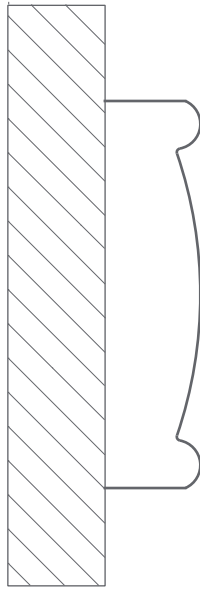

**H024**

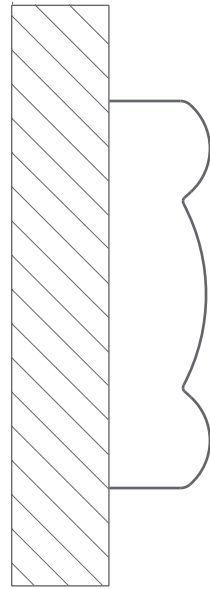

**H032**

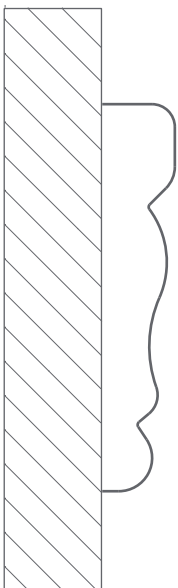

**H007**

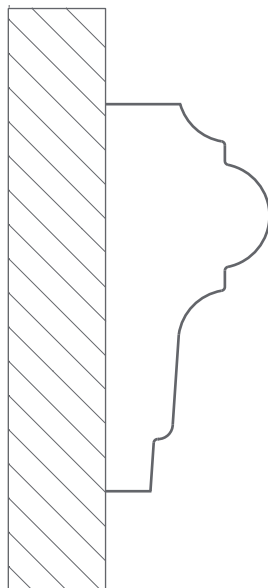

**H009**

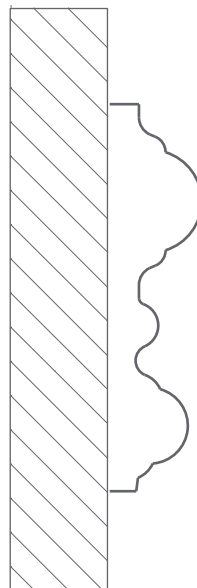

**H015**

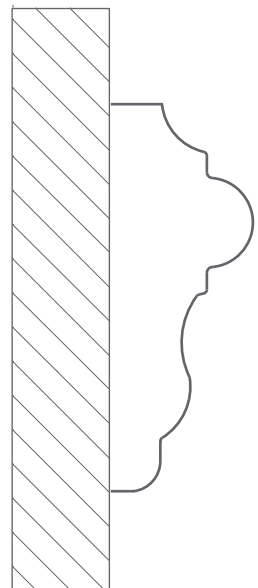

**H016**

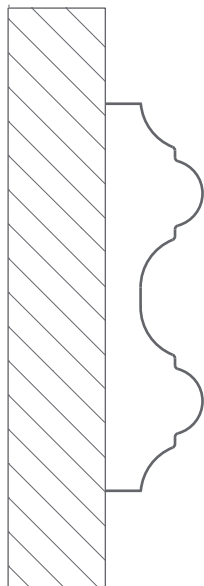

**H019**

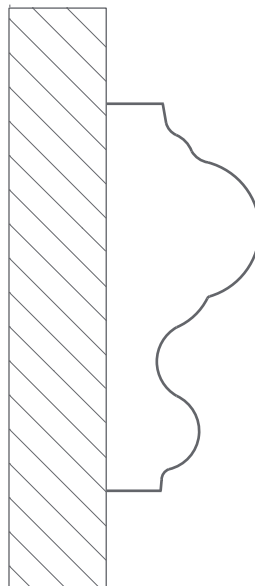

**H028**

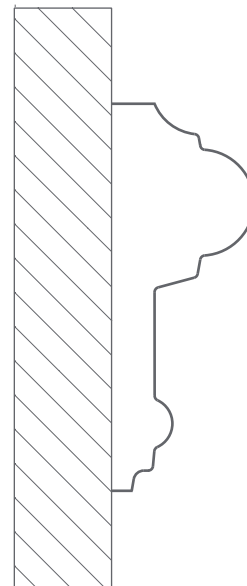

**H031**

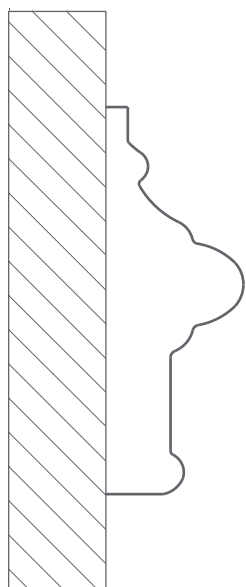

**H033**

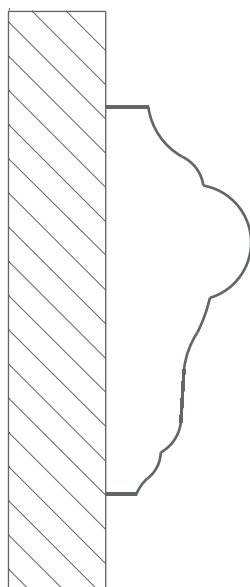

**H001**

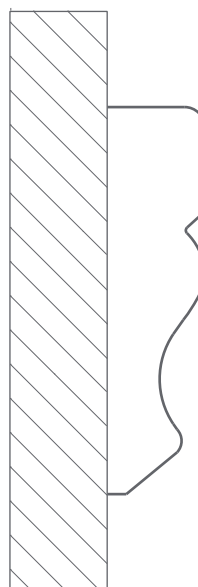

**H003**

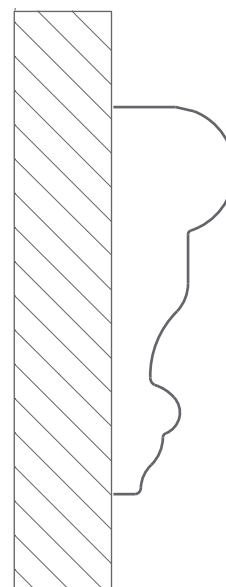

**H004**

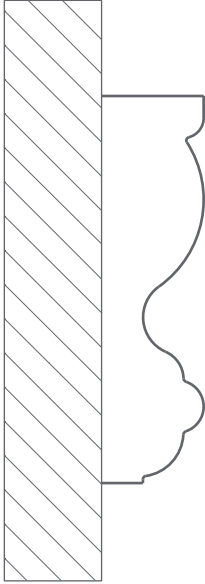

**H005**

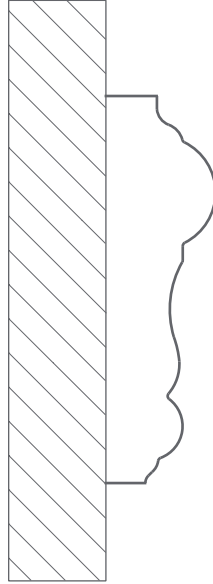

**H006**

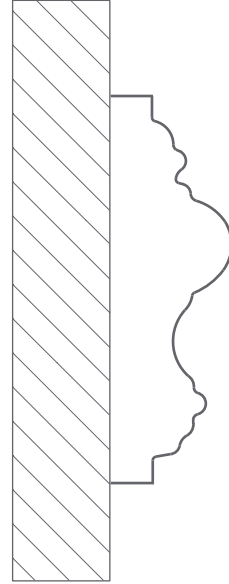

**H008**

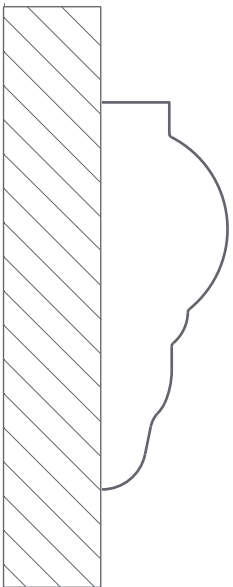

**H010**

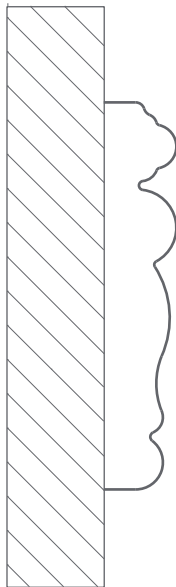

**H011**

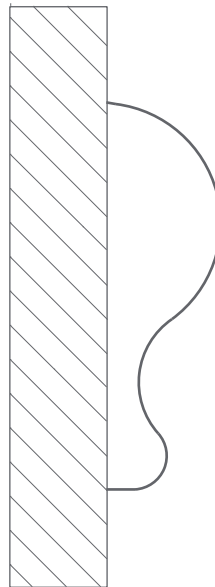

**H012**

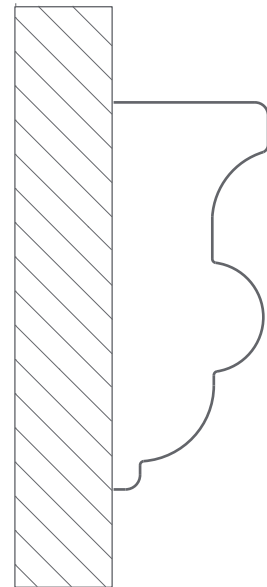

**H013**

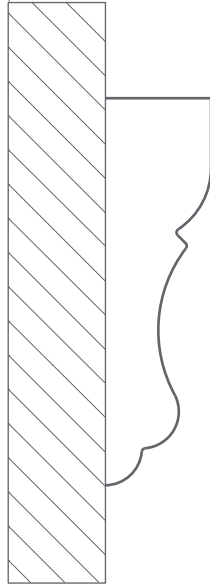

**H014**

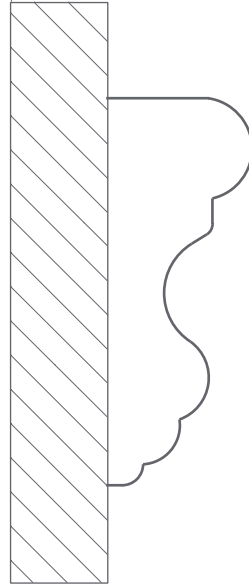

**H017**

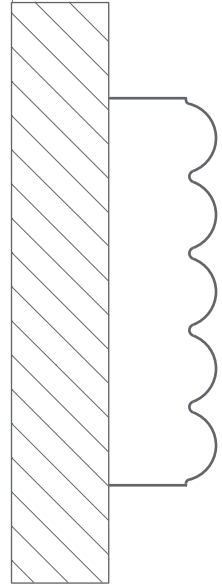

**H020**

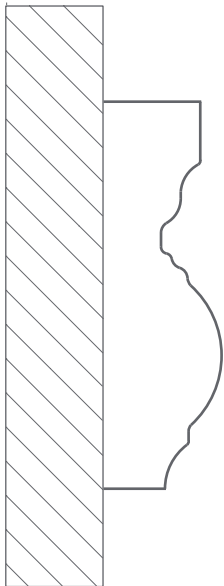

**H021**

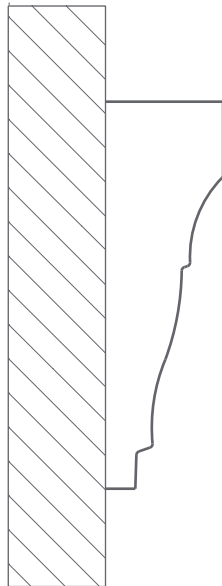

**H022**

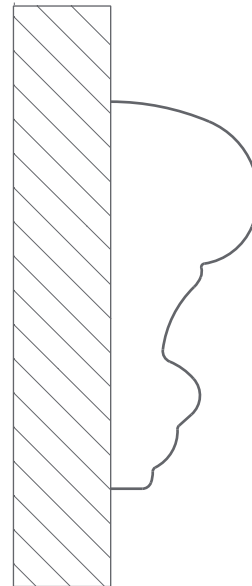

**H023**

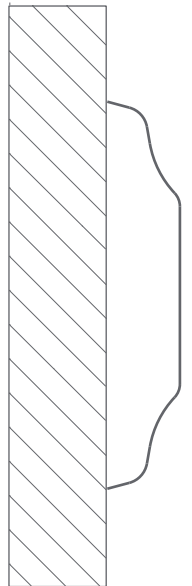

**H025**

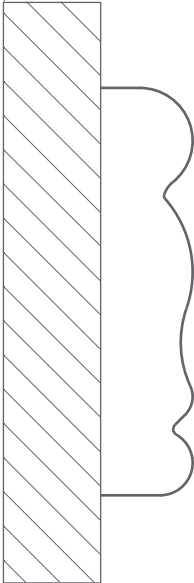

**H026**

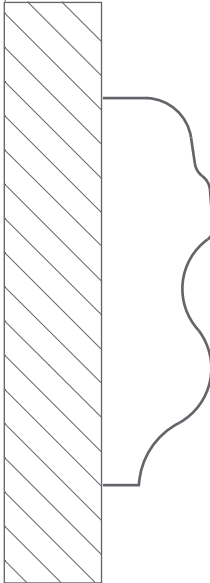

**H027**

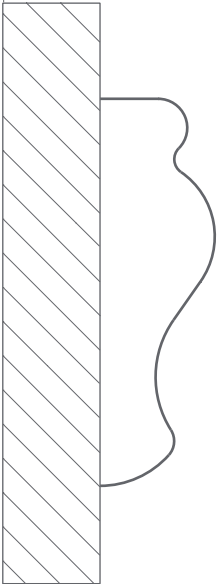

**H029**

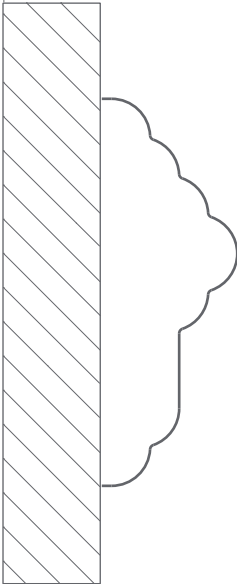

**H030**

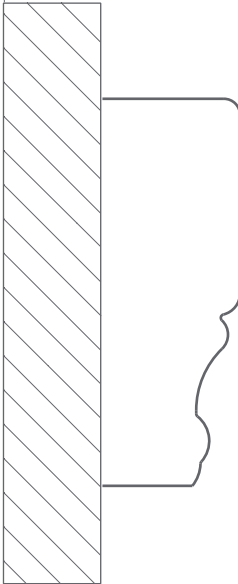



# Lambris

wood paneling

ÉCHELLE 1:1

# couteau pour fabriquer l'arrière des planches de lambris

Knife to make back of wood planks paneling

L901

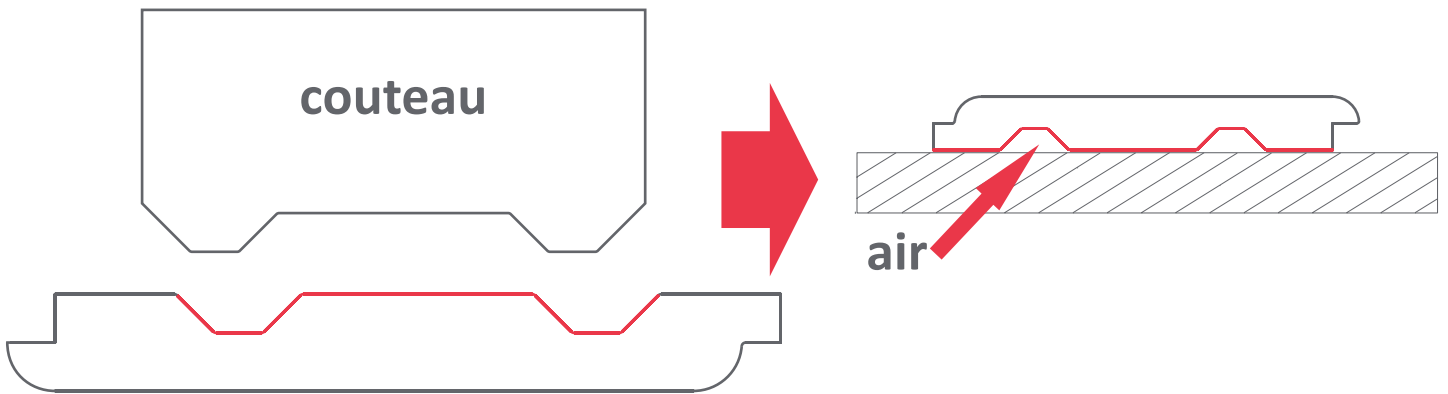

L902

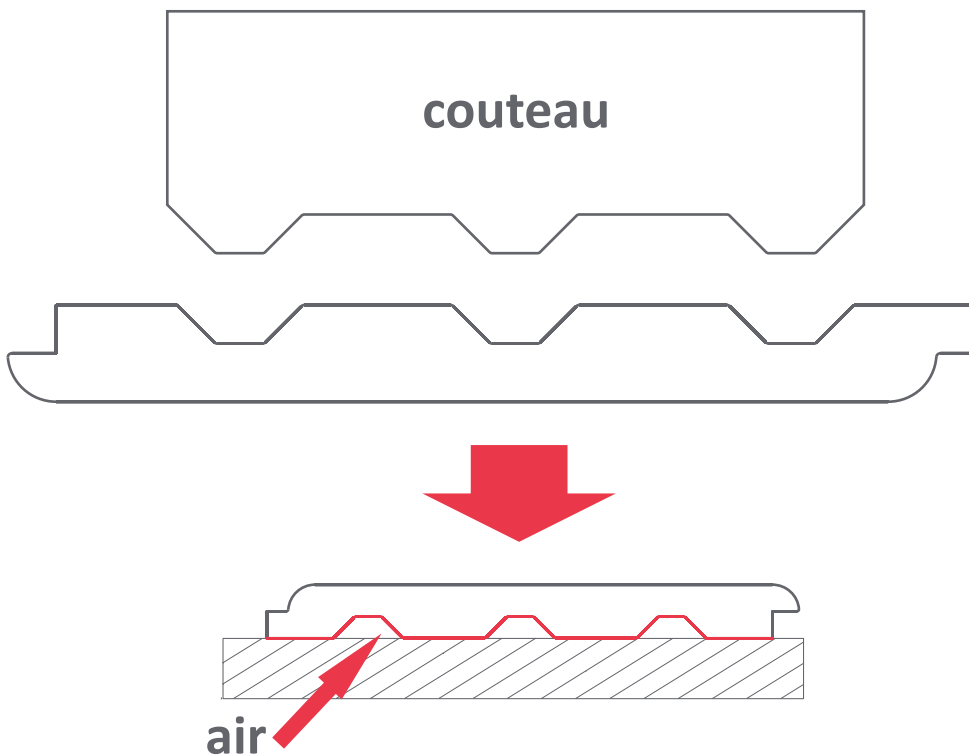

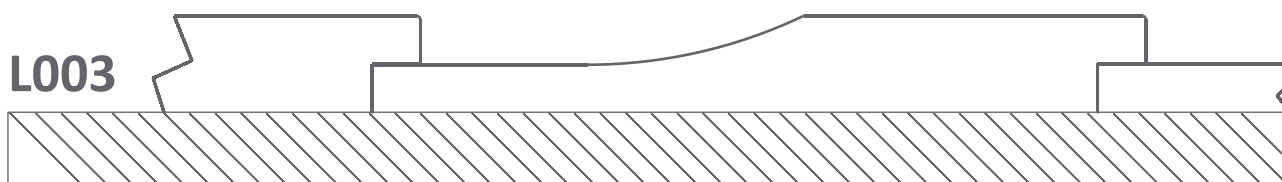

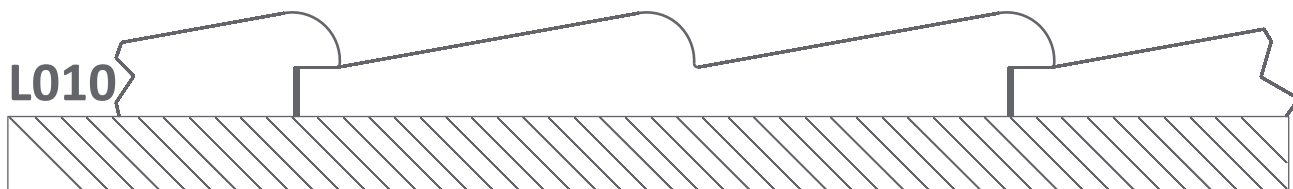
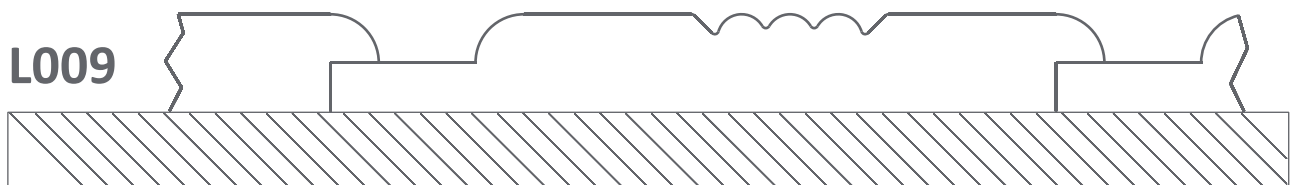
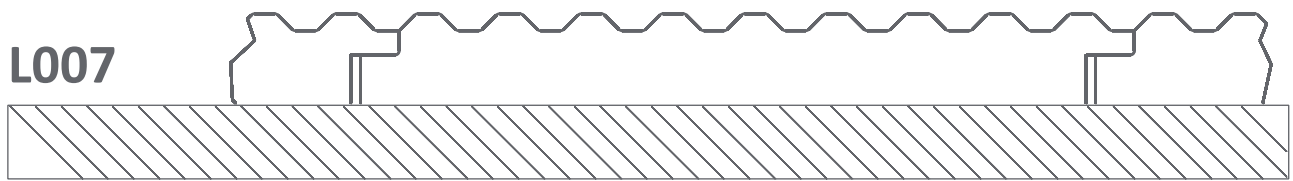
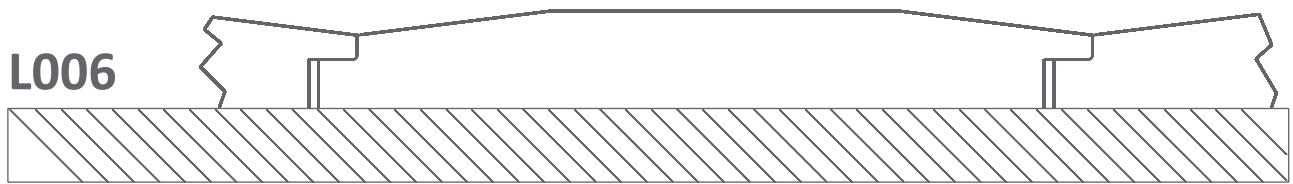

# Main-courante

## handrail

ÉCHELLE 1:1

# Main-courante

handrail

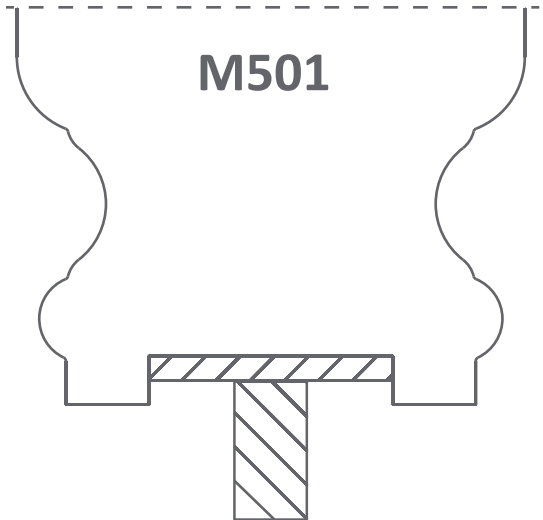
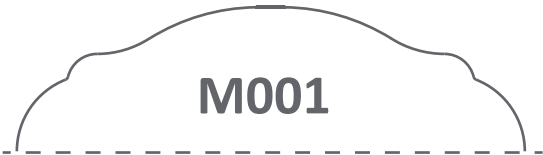

**M001-M501**

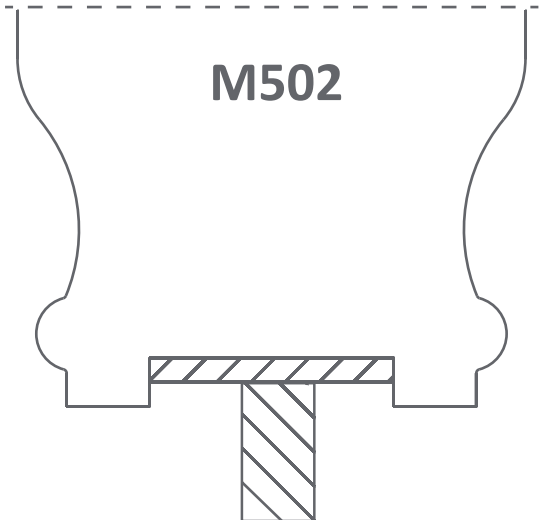
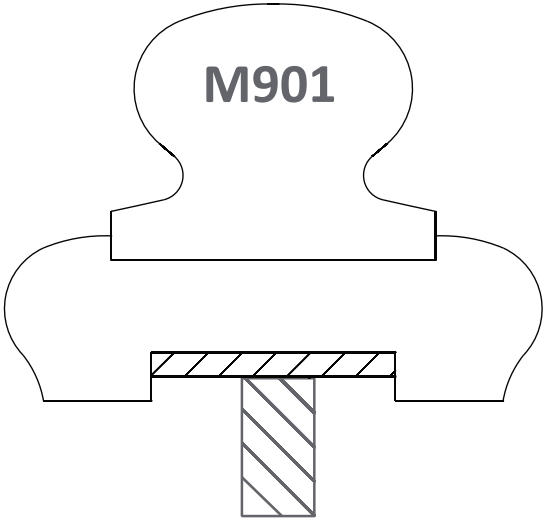

**M002-M502**

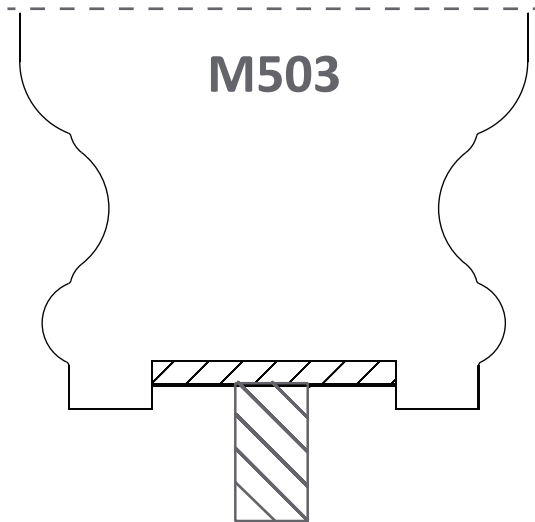
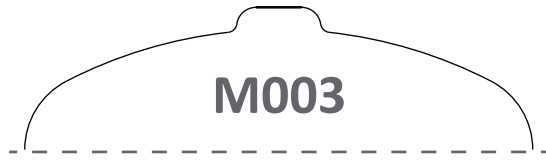

M003-M503

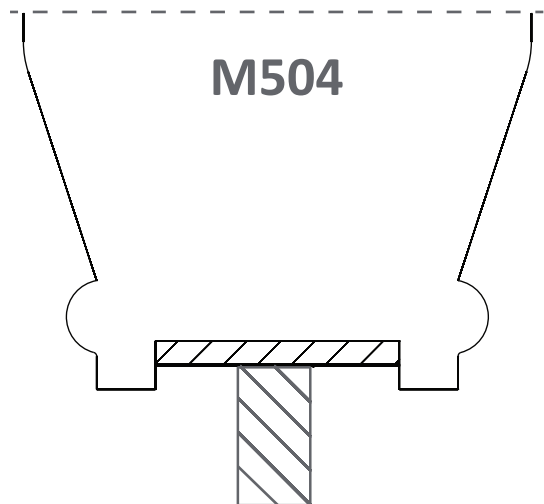

M004-M504

# Main-courante

handrail

Tous les modèles de main-courantes disponibles  
All available models of handrail

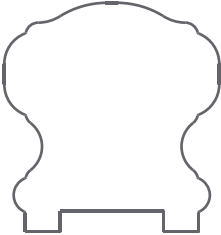
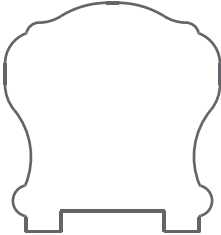
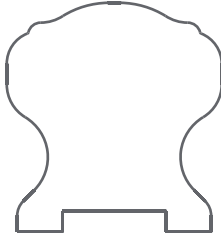
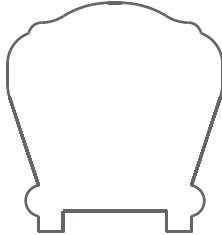
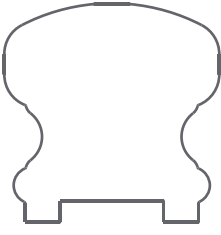
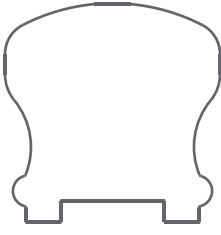
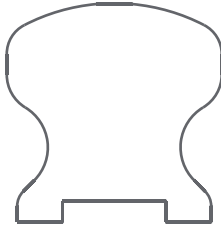
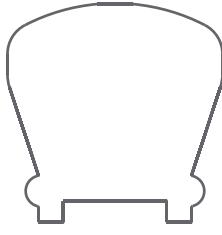
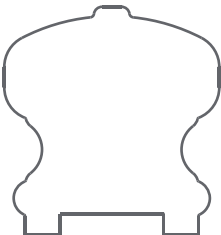
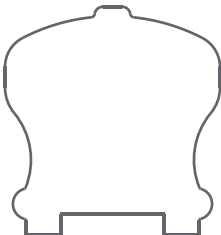
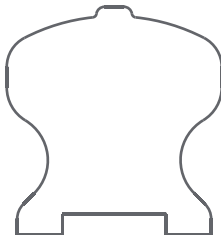
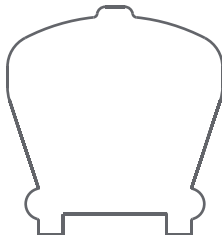
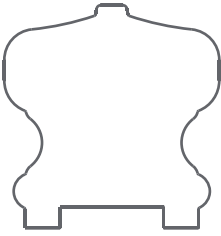
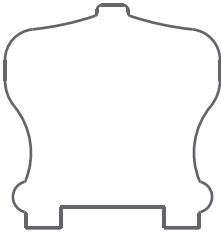
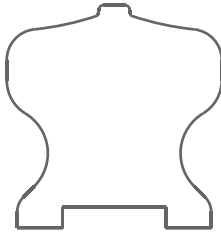
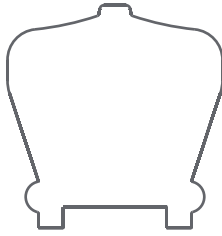
	M501	M502	M503	M504
M001				
M002				
M003				
M004				



# Multi-profils

multi-profiles

ÉCHELLE 1:1

# Multi-profilis

multi-profiles

**N001**

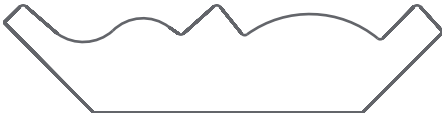

## N002



## N003

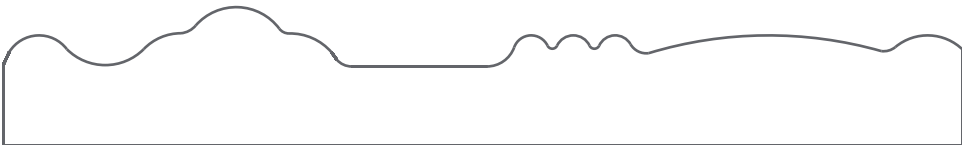
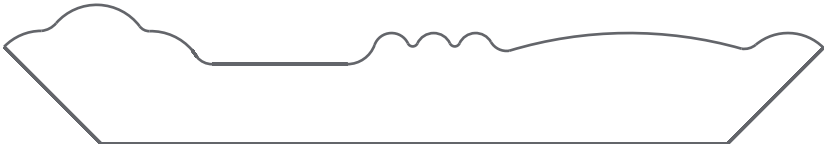
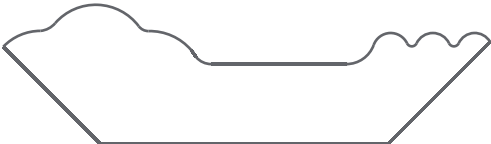
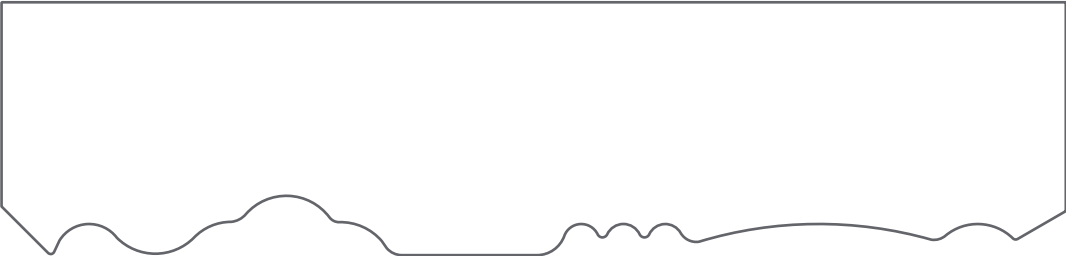

# Plinthe

## baseboard

ÉCHELLE 1:1

# couteau pour fabriquer l'arrière des plinthes

Knife to make back of baseboard

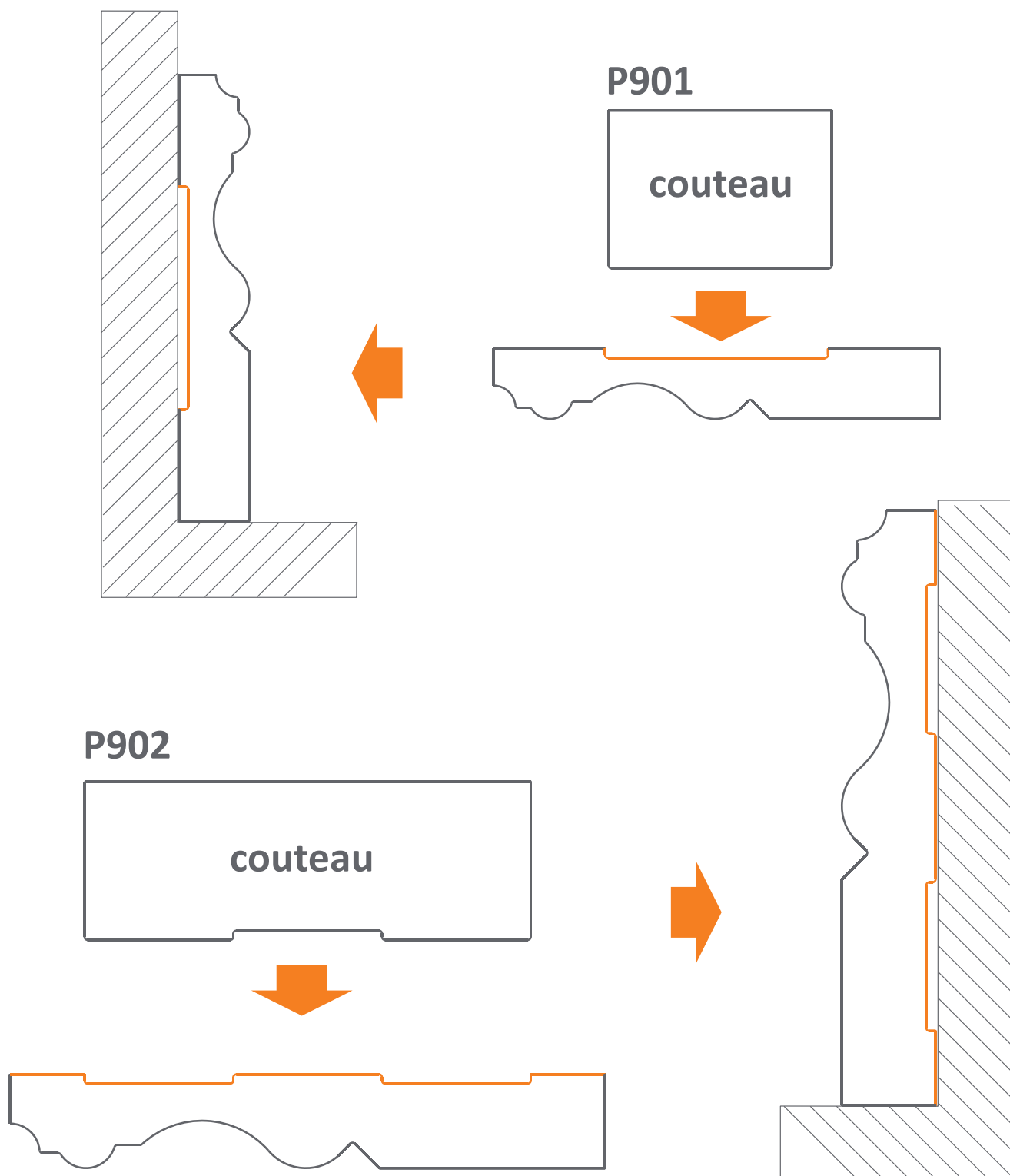

**P001**

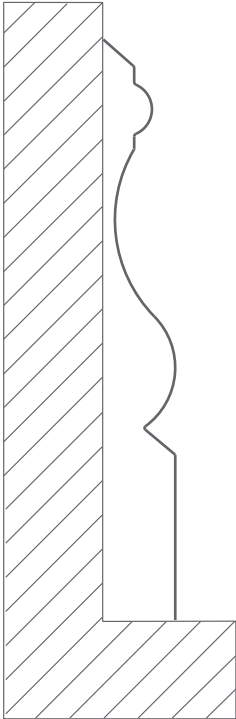

**P007**

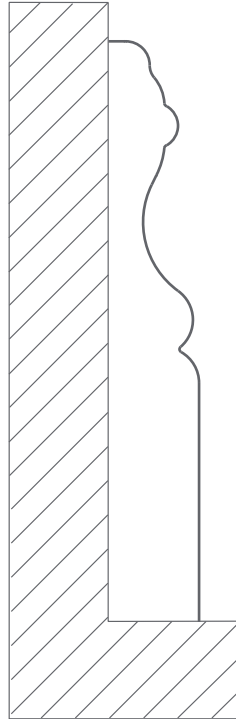

**P009**

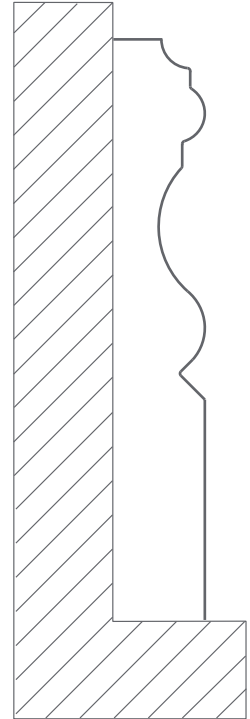

**P018**

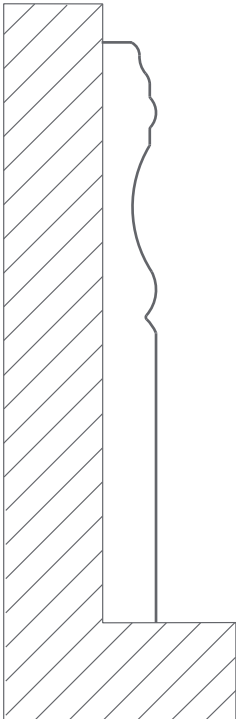

**P020**

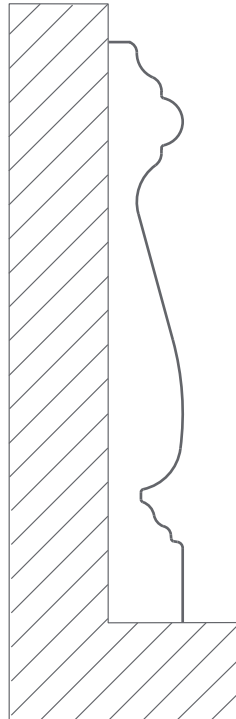

**P037**

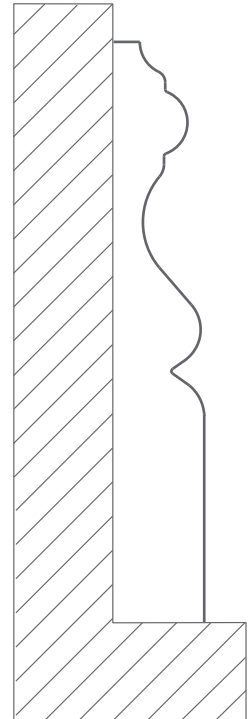

**P045**

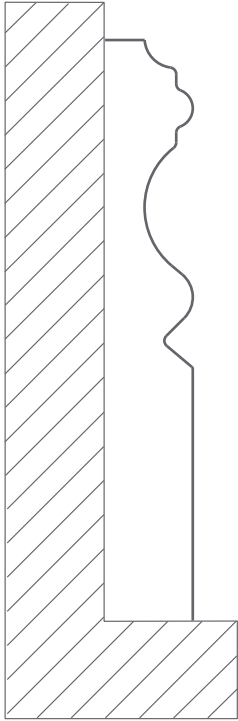

**P046**

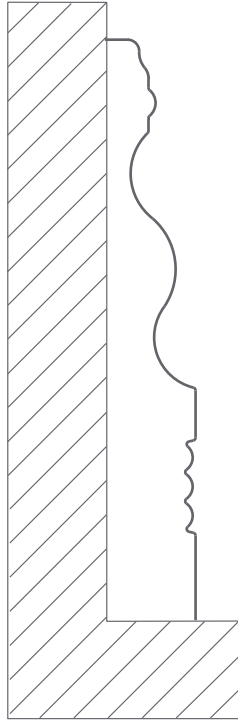

**P048**

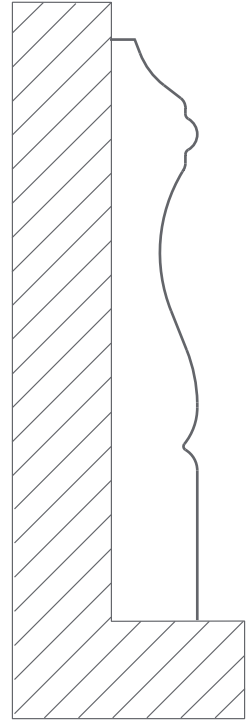

**P049**

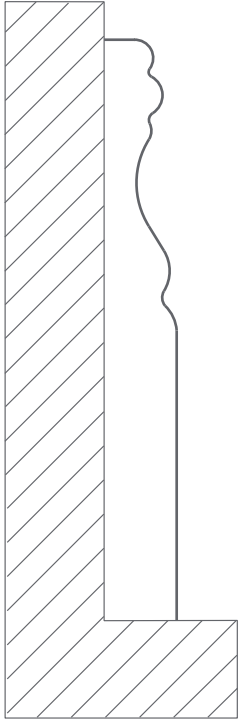

**P050**

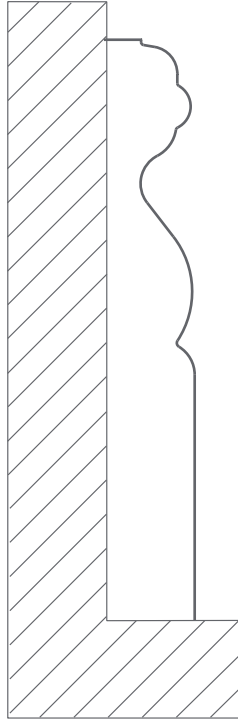

**P005**

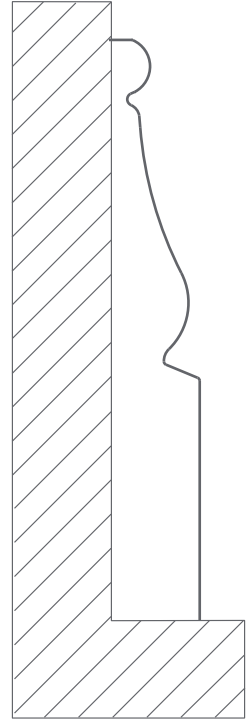



**P006**

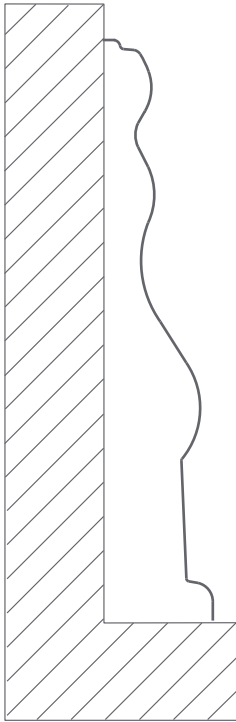

**P010**

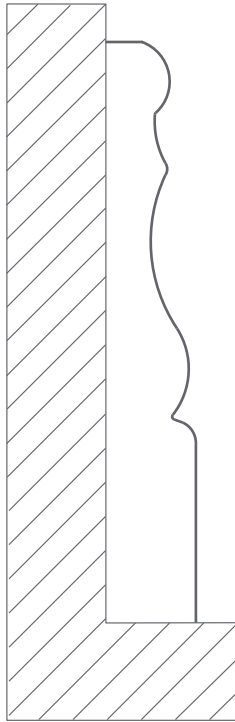

**P011**

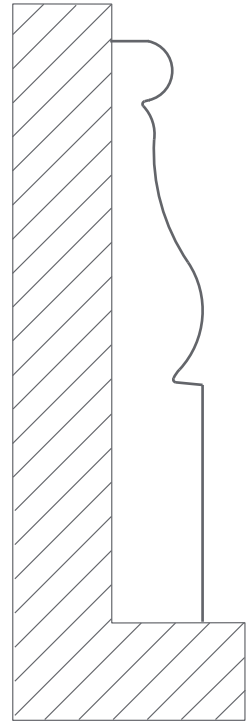

**P012**

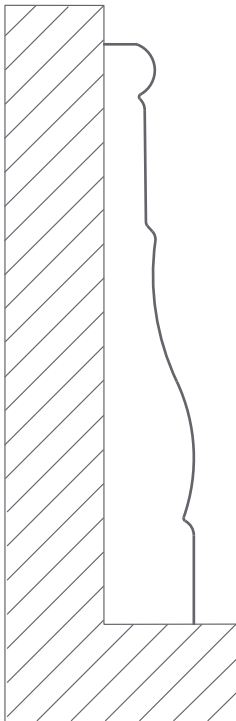

**P041**

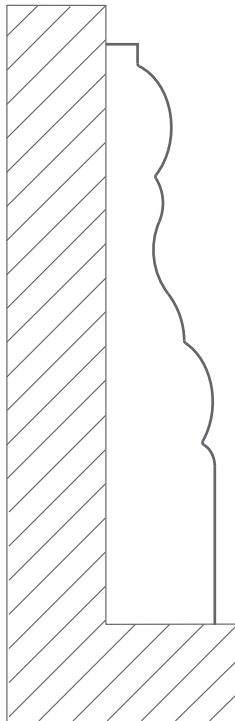

**P016**

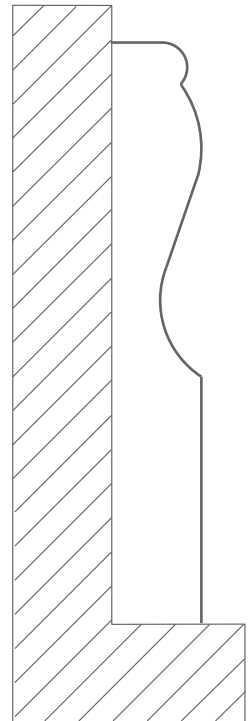

**P023**

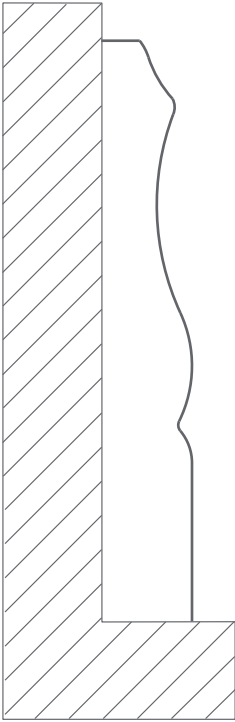

**P024**

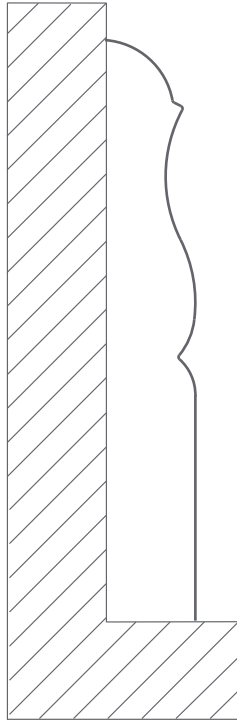

**P025**

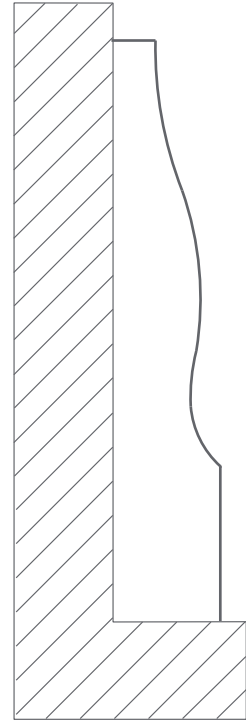

**P027**

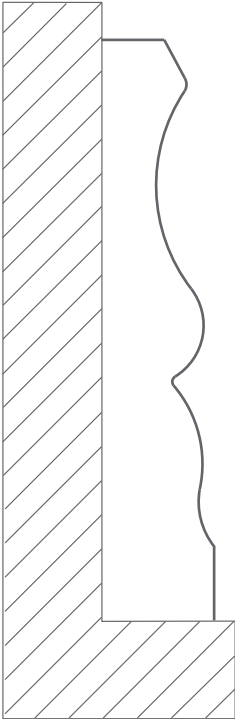

**P039**

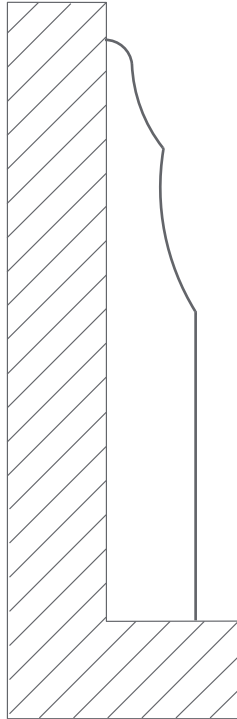

**P051**

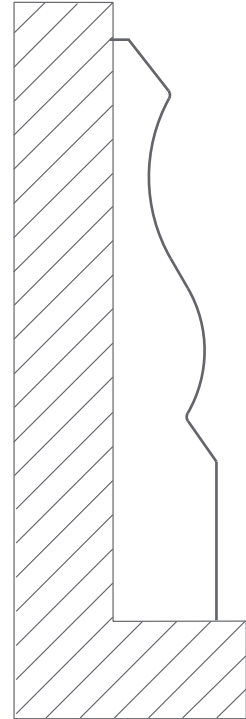

**P057**

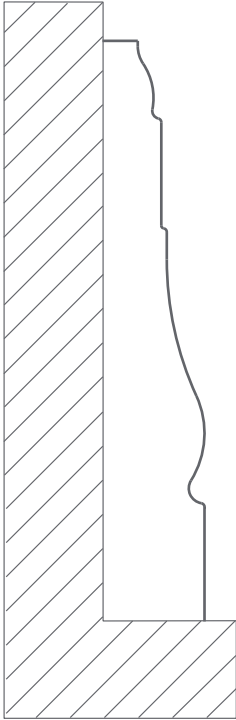

**P003**

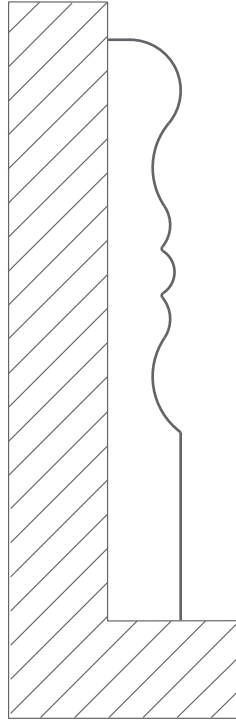

**P014**

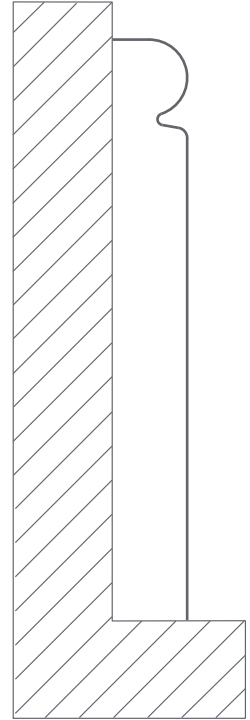

**P040**

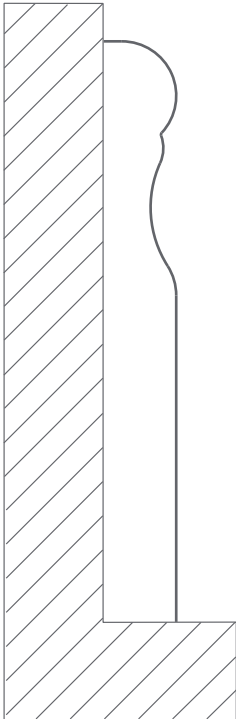

**P044**

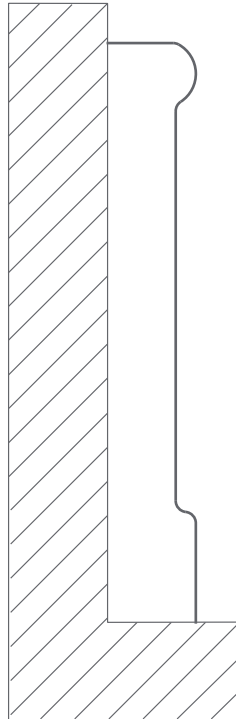

**P002**

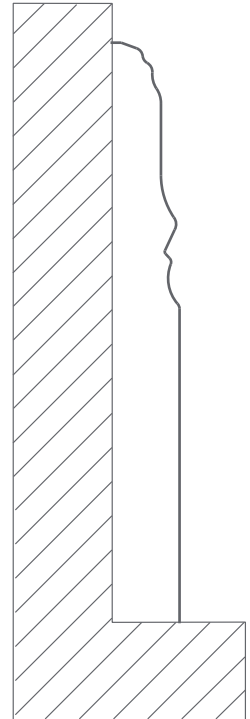

**P004**

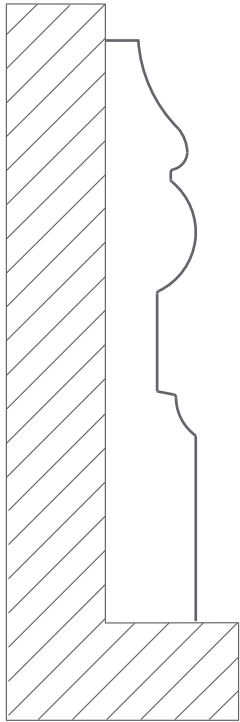

**P008**

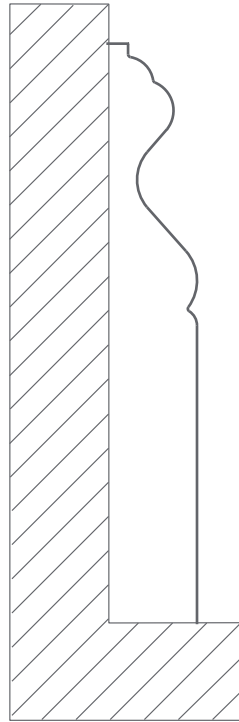

**P013**

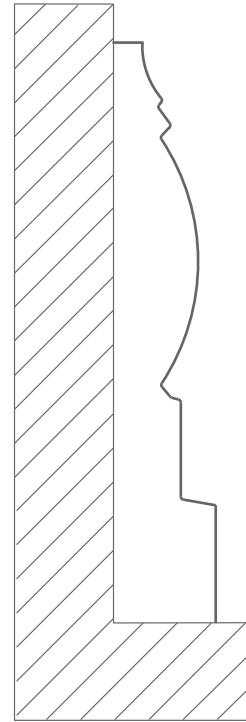

**P015**

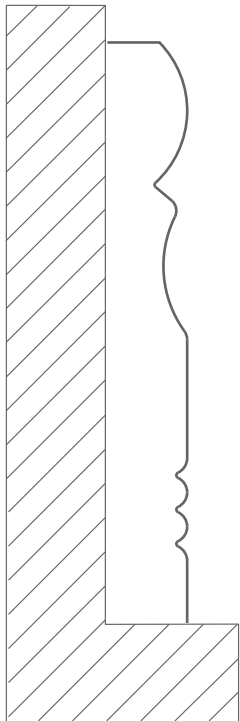

**P017**

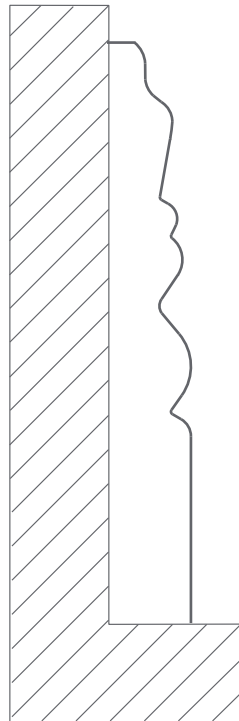

**P019**

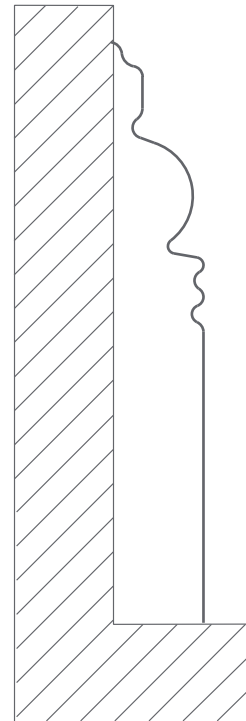

**P021**

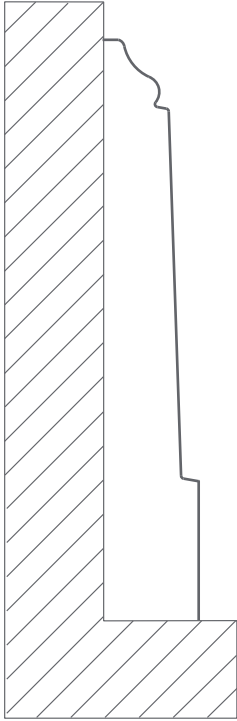

**P022**

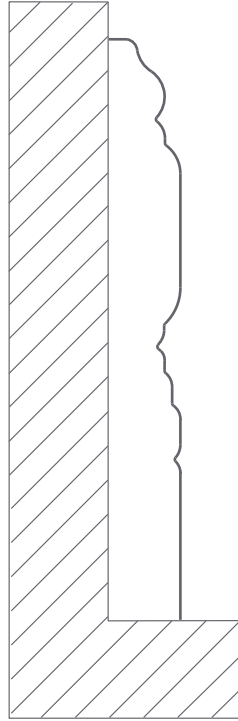

**P026**

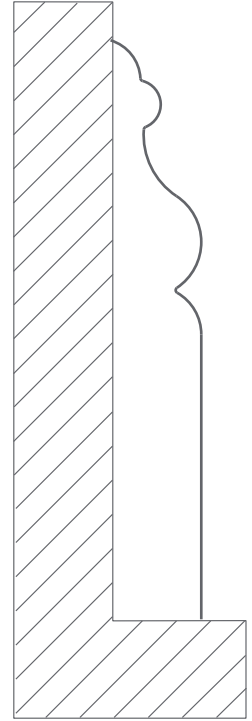

**P028**

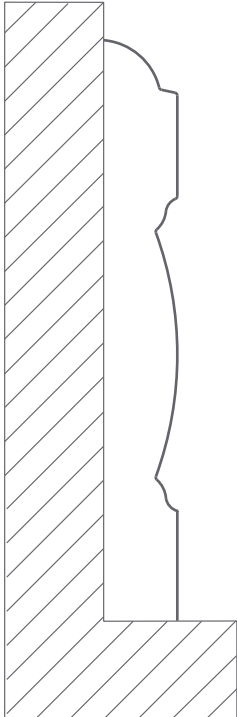

**P029**

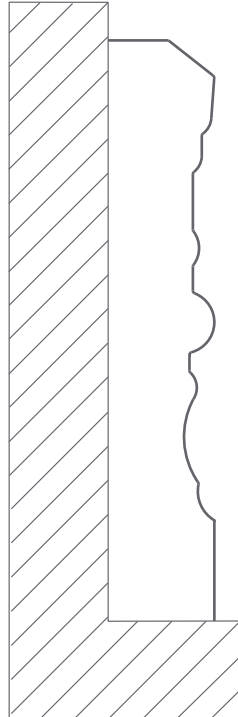

**P030**

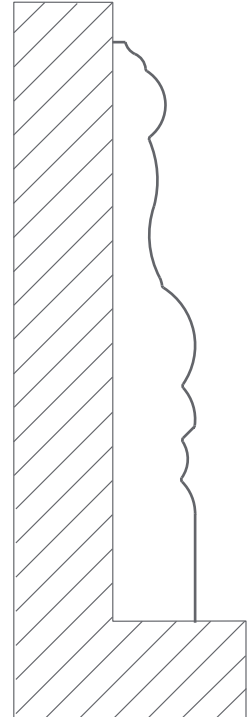

**P031**

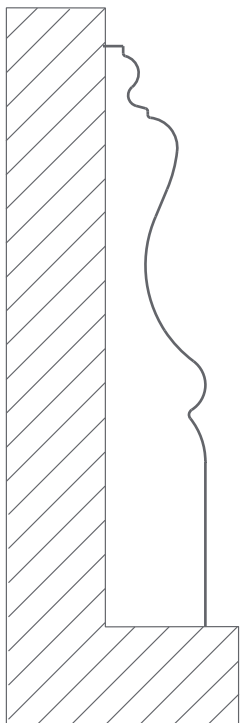

**P032**

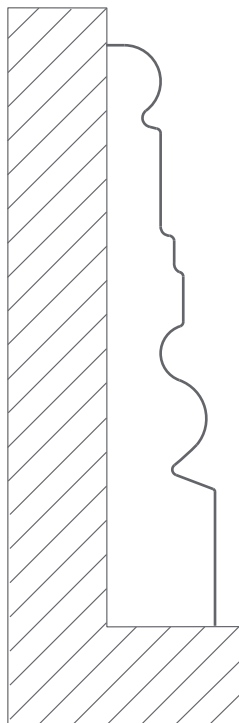

**P033**

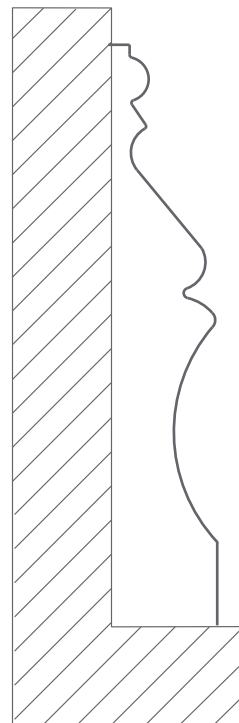

**P034**

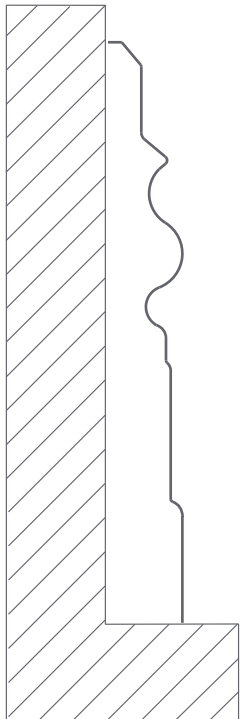

**P035**

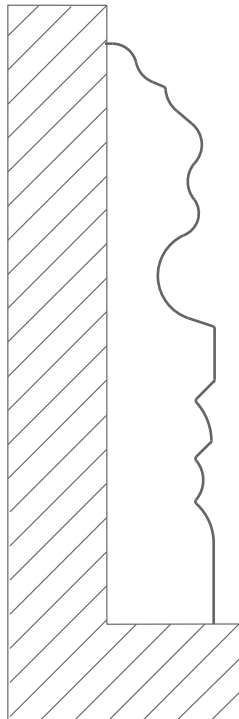

**P036**

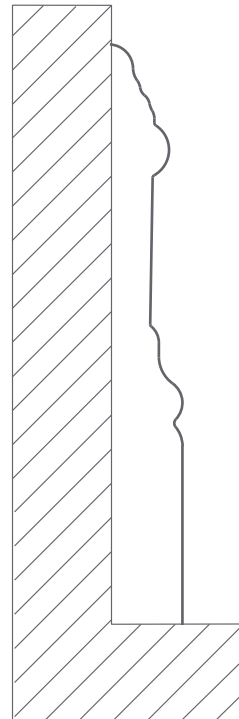

**P038**

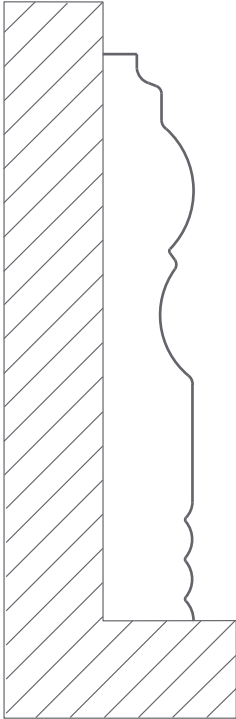

**P042**

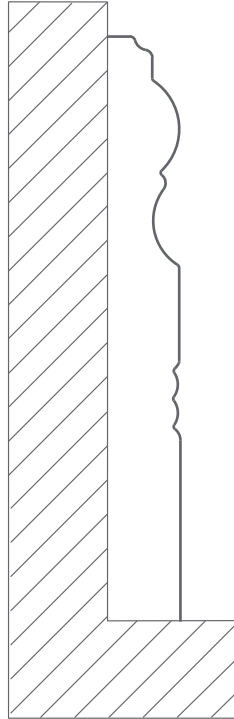

**P043**

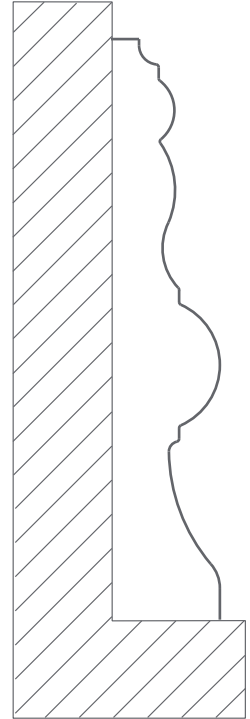

**P047**

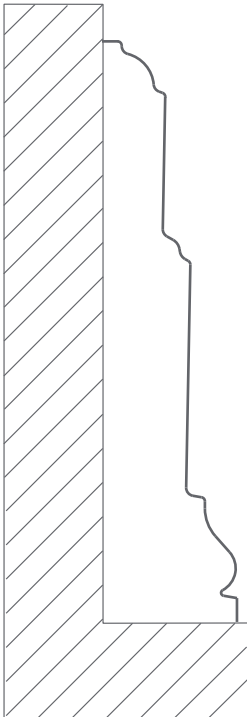

**P052**

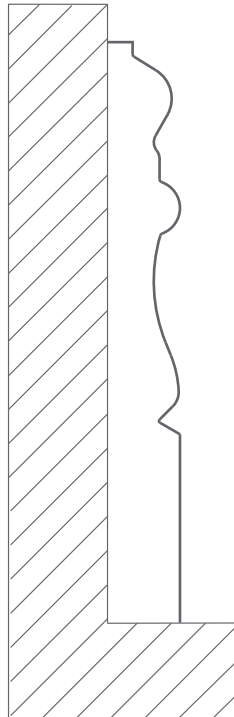

**P053**

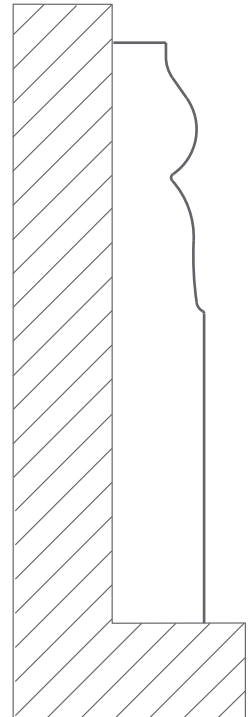

# Plinthe

baseboard

**P054**

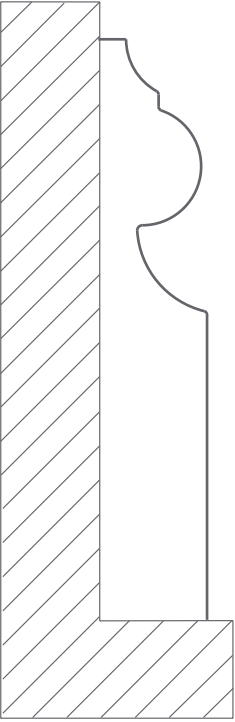

**P055**

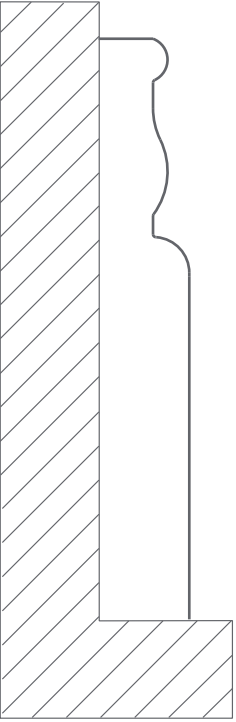

**P056**

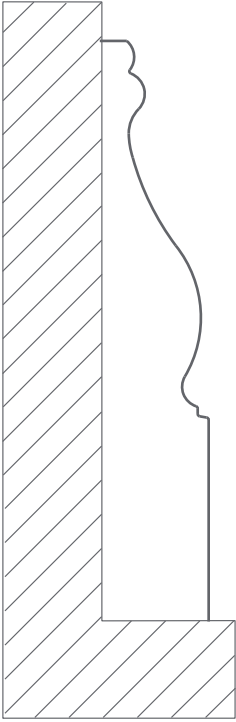

**P058**

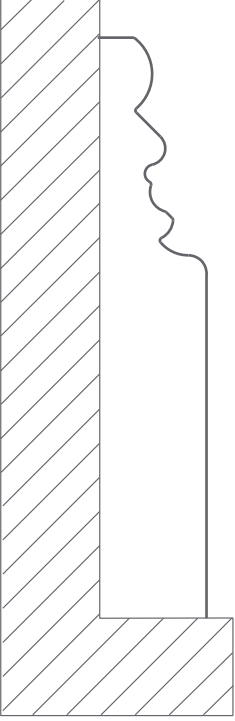

**P059**

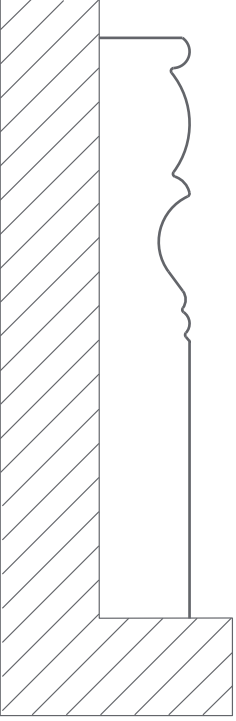

**P060**

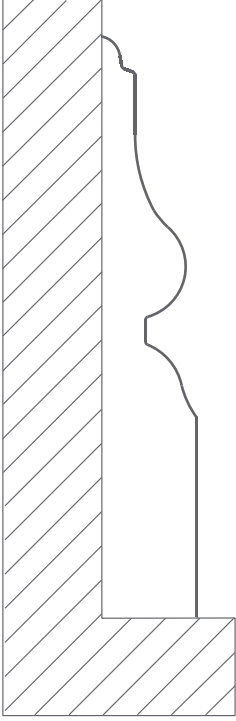



# Profil standard

standard profile

ÉCHELLE 1:1

# Profil standard

standard profile

**Q001**

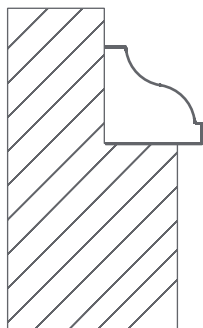

**Q005**

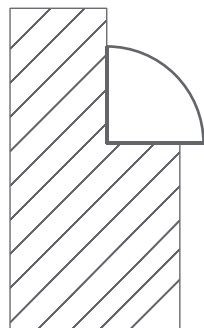

**Q006**

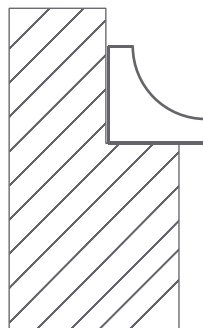

**Q007**

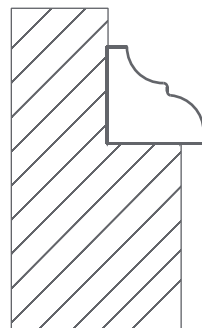

**Q008**

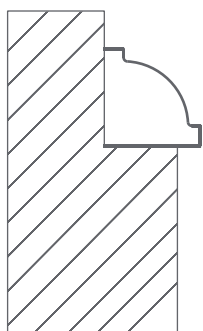

**Q009**

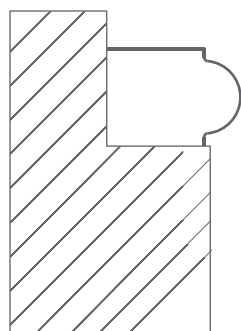

**Q010**

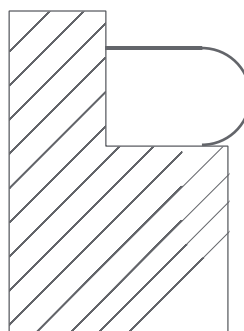

**Q011**

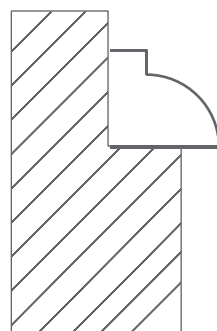

**Q002**



Utiliser pour le bureau secrétaire,  
l'armoire à pain etc...

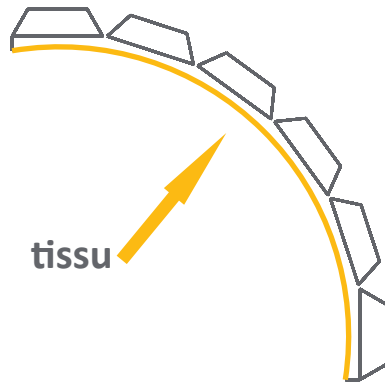

**Q003**

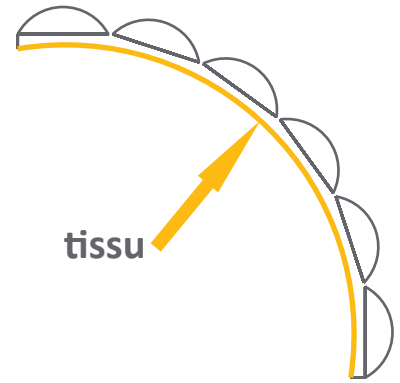

**Q004**

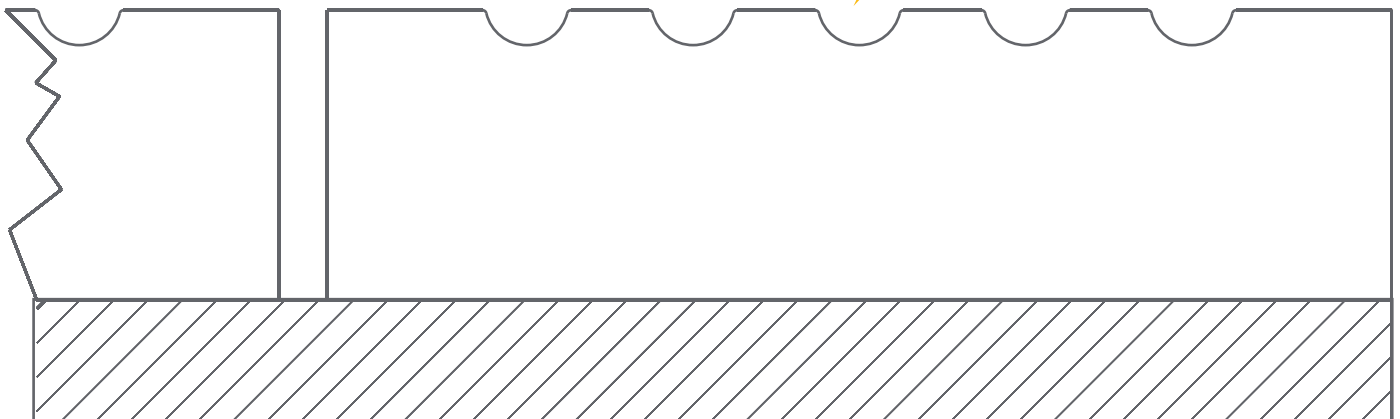

Utilisé pour fabriquer  
une surface antidérapante

# Profil standard

standard profile

## Q012

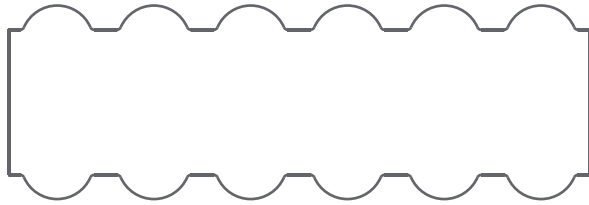

Utiliser pour sécher le bois



Bois humide



## Q013



Profil réversible



solution A



solution B

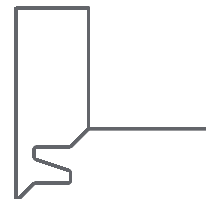

# Rosette

rosette

ÉCHELLE 1:1

2 en 1  
Deux solutions possibles

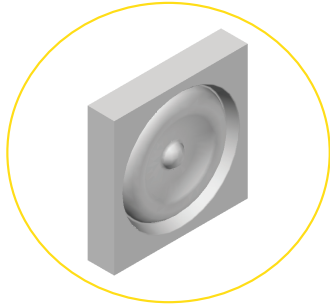

**R001**

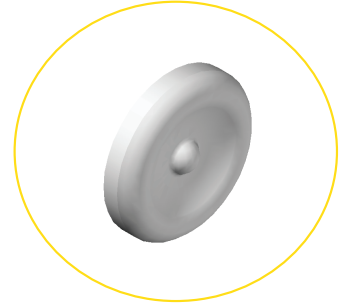

2 en 1  
Deux solutions possibles

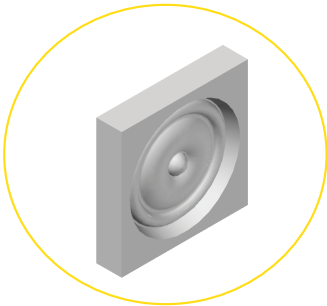

**R002**

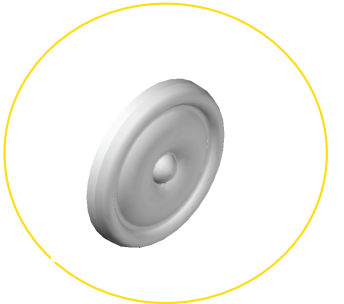

2 en 1  
Deux solutions possibles

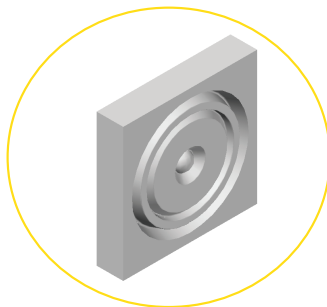

**R007**

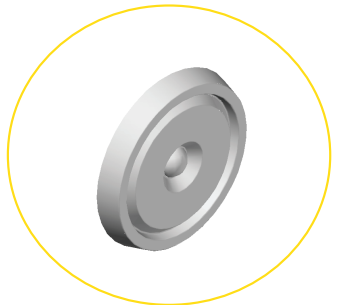

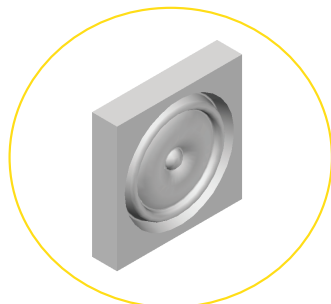

**R008**



2 en 1  
Deux solutions possibles

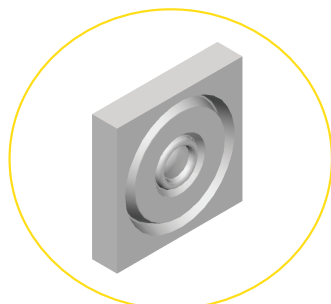
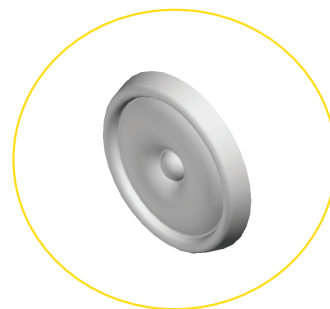

**R009**



2 en 1  
Deux solutions possibles

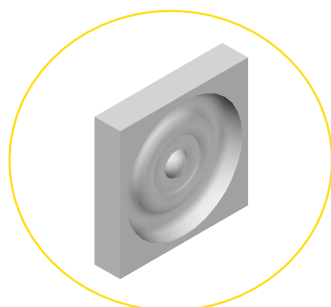
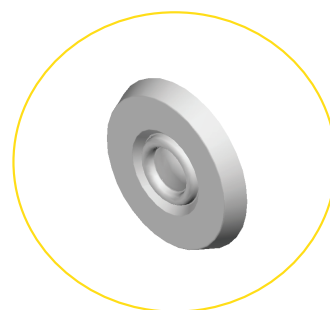

**R003**



**R004**

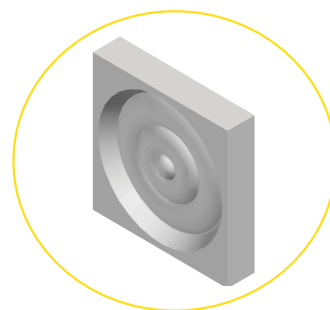

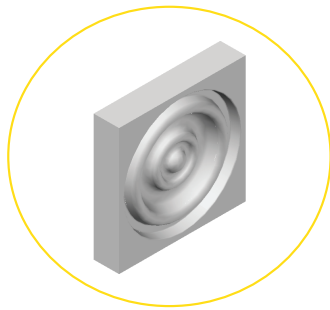

**R005**

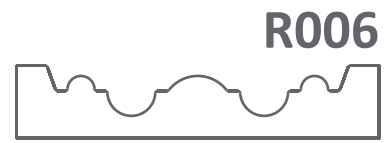

**R006**

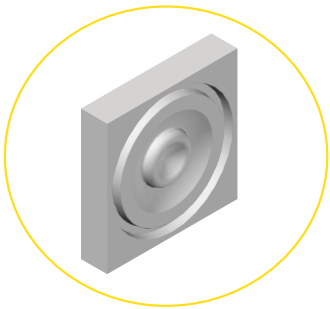
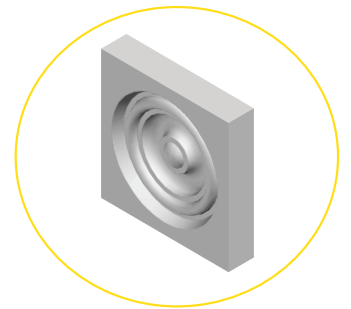

**R010**



**R011**

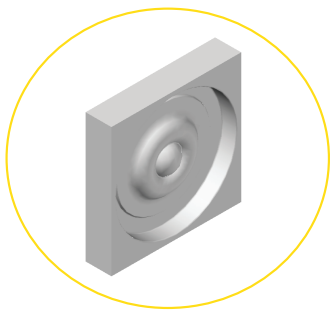
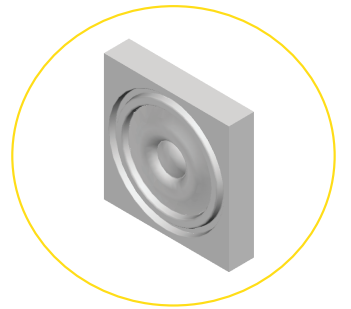

**R012**





# Appliqué

astragal

ÉCHELLE 1:1

# Appliqué

astragal

**S001**

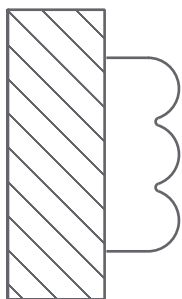

**S002**

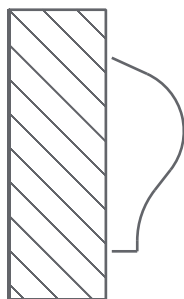

**S003**

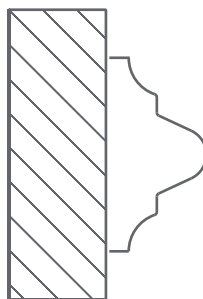

**S004**

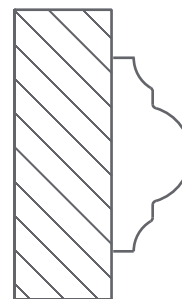

**S005**

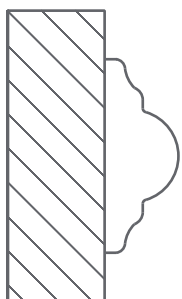

**S006**

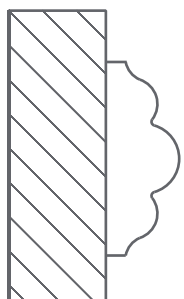

**S007**

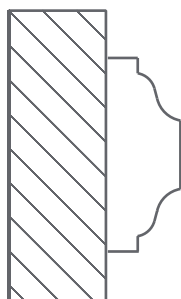

**S008**

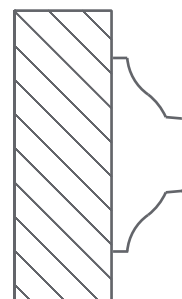

**S009**

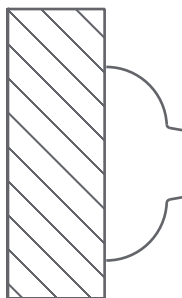

**S010**

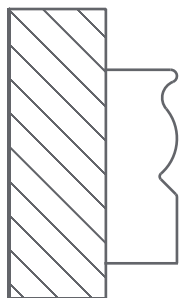

**S011**

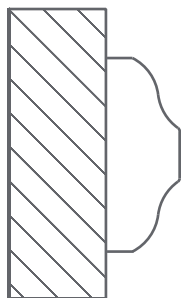

**S012**

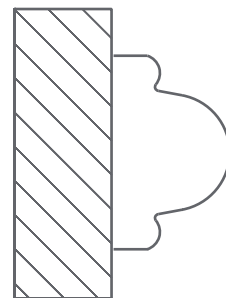

# Embouveté

tongue and groove

ÉCHELLE 1:1

# Embouveté

tongue and groove

## couteau pour fabriquer l'arrière des planches embouvetées

Knife to make back of tongue and groove planks

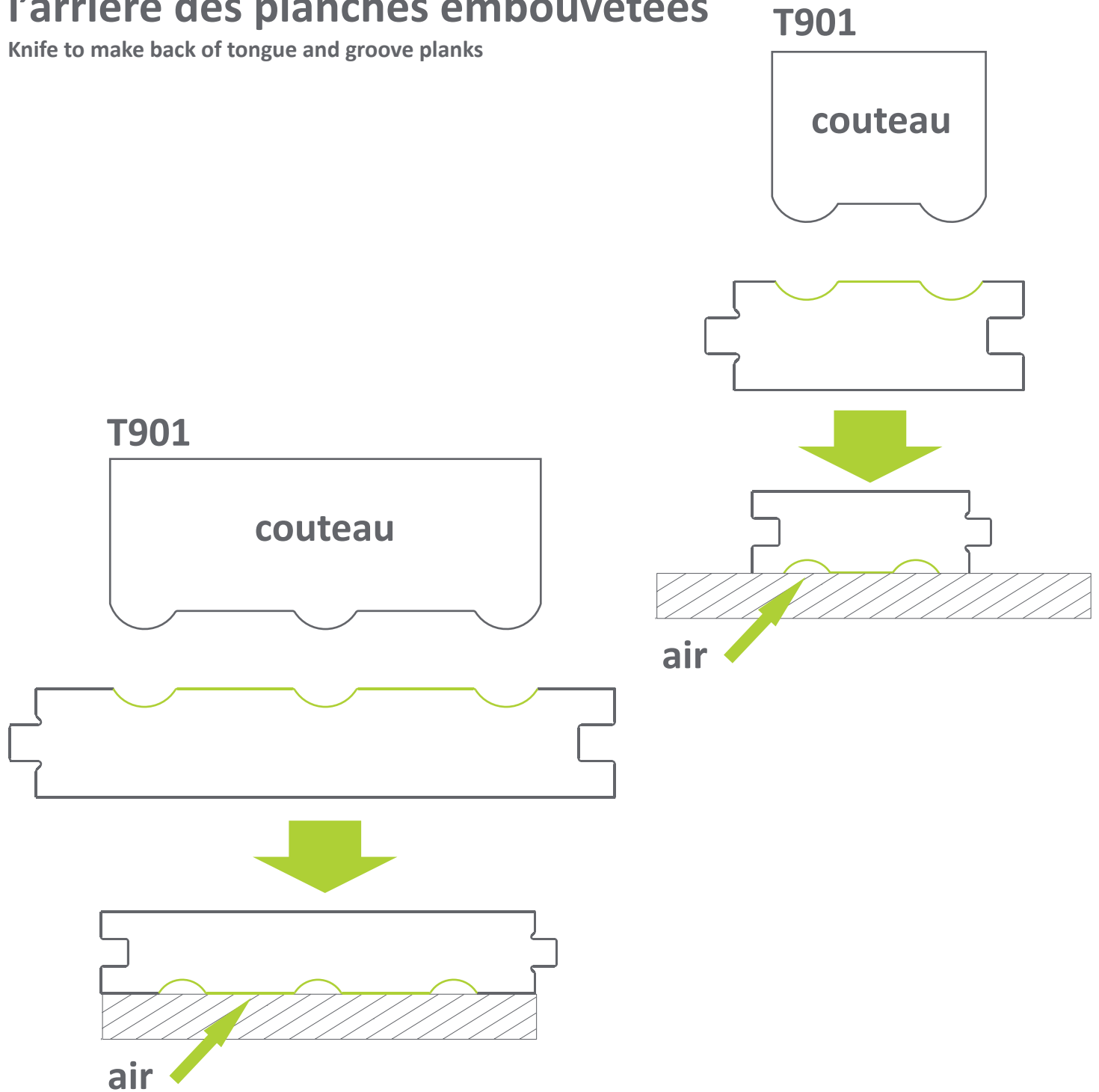

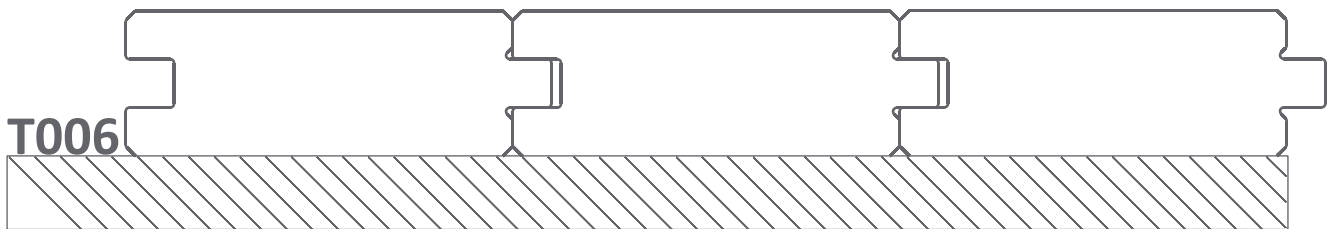
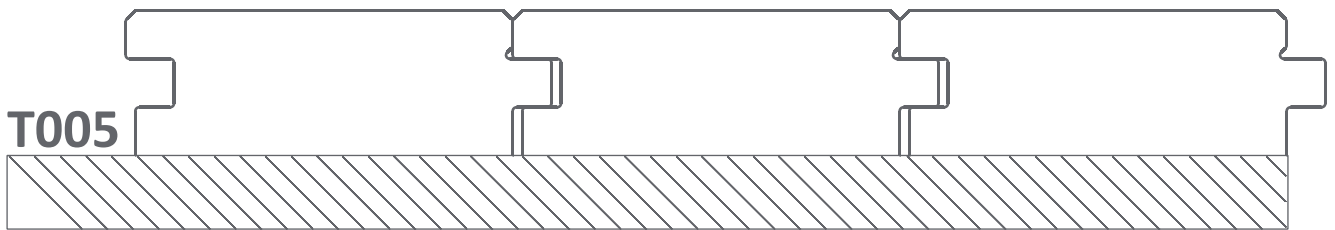
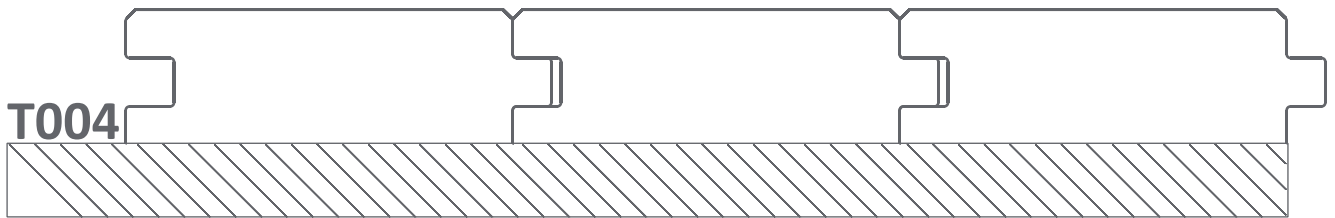
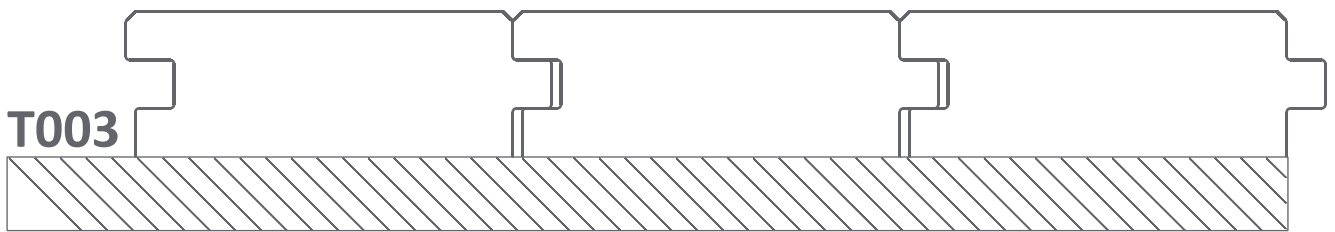
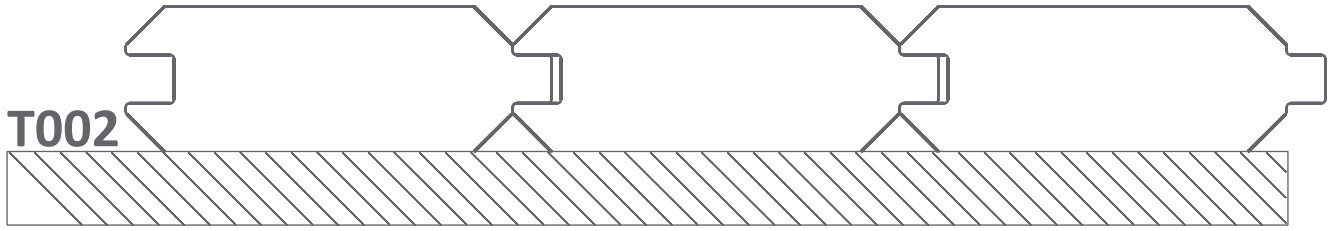
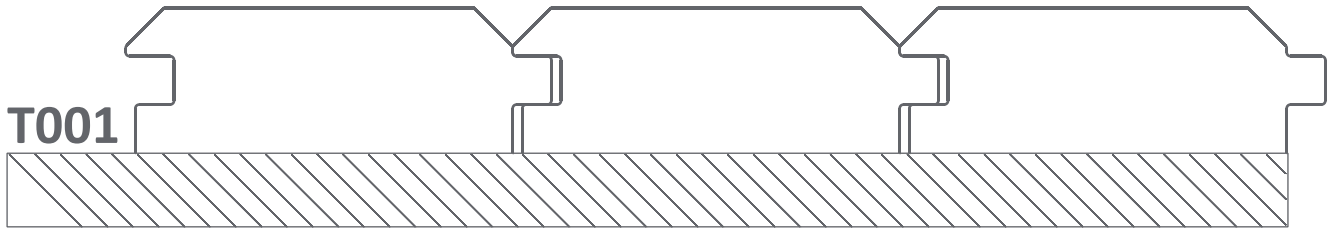

# Embouveté

tongue and groove

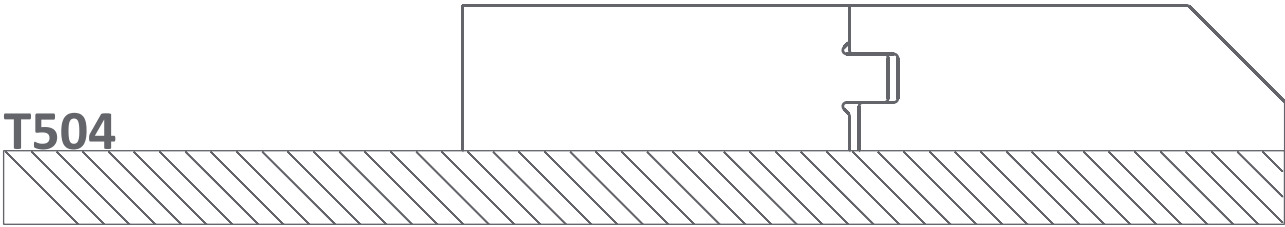
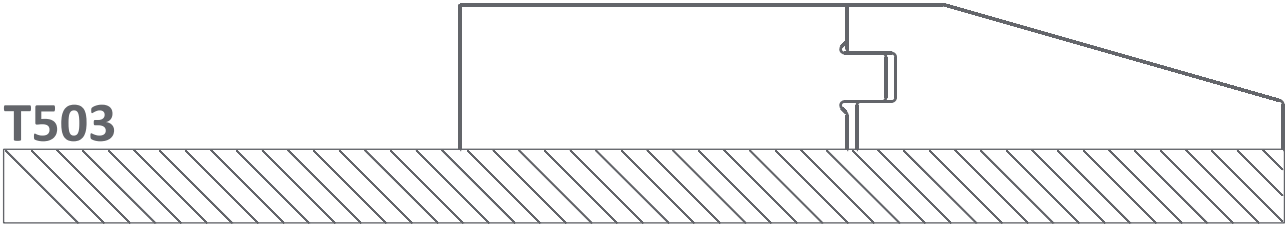
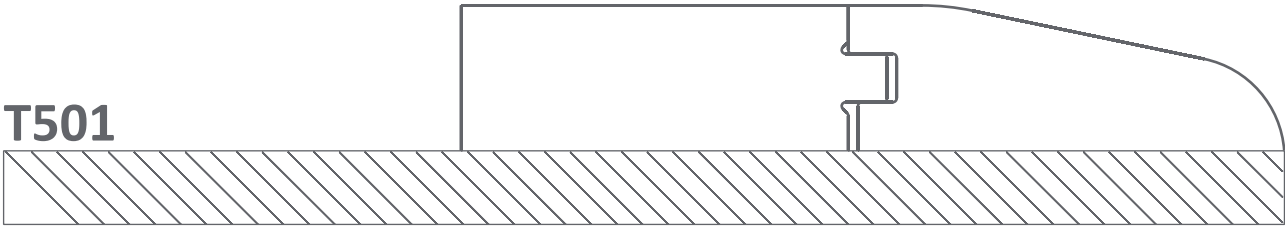
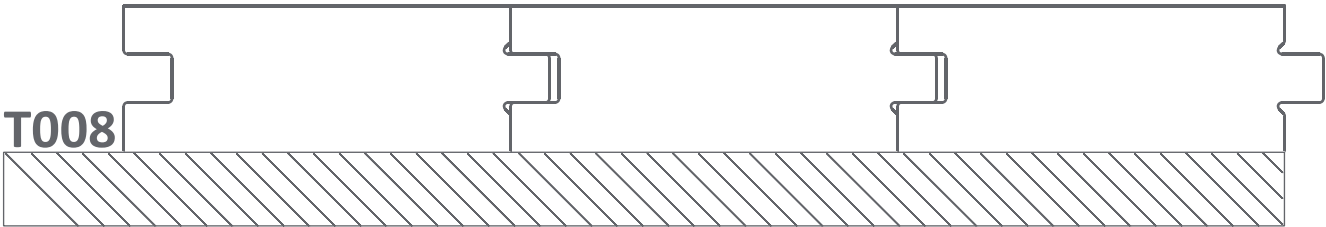
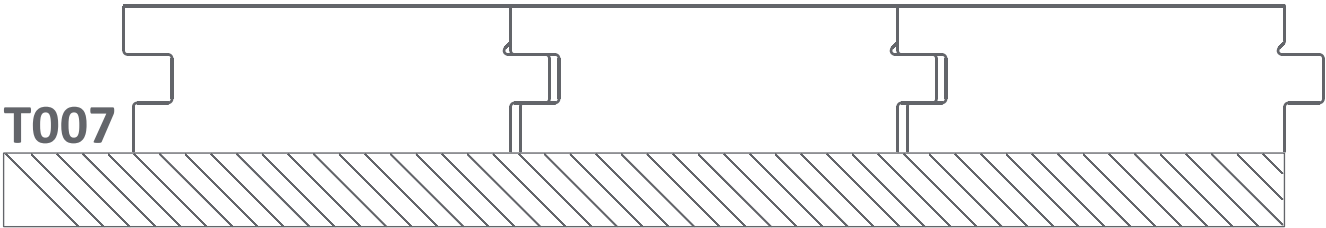

# Corniche

cornice

ÉCHELLE 1:1

# Corniche

cornice

## couteau pour fabriquer l'arrière des corniches

Knife to make back of cornice

V901

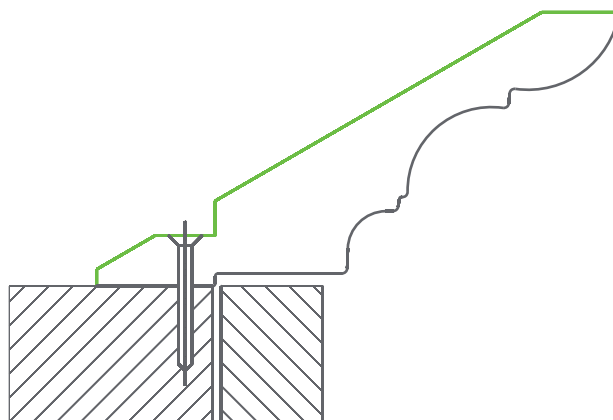
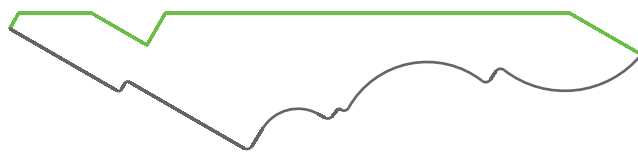



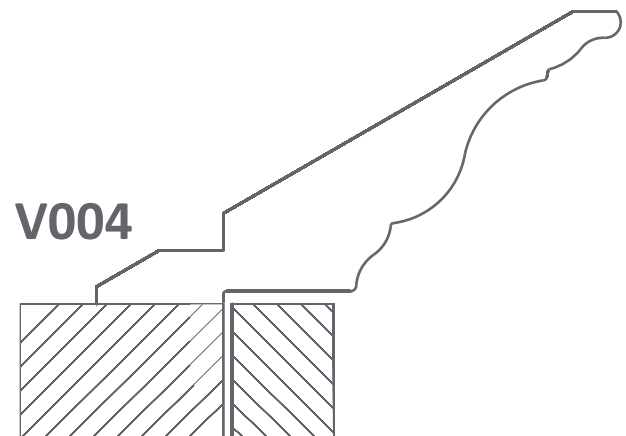
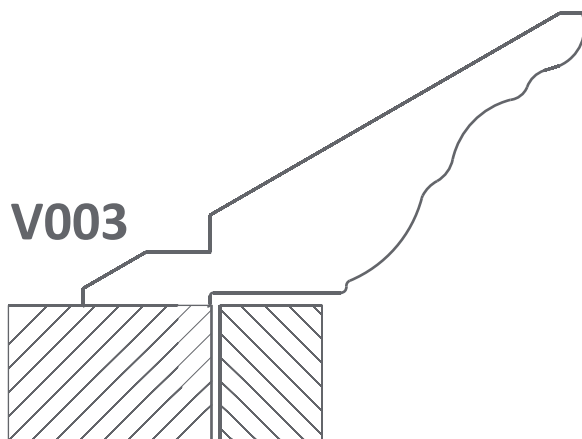
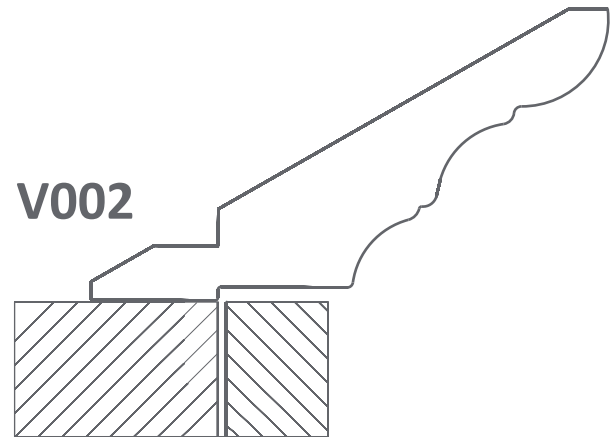
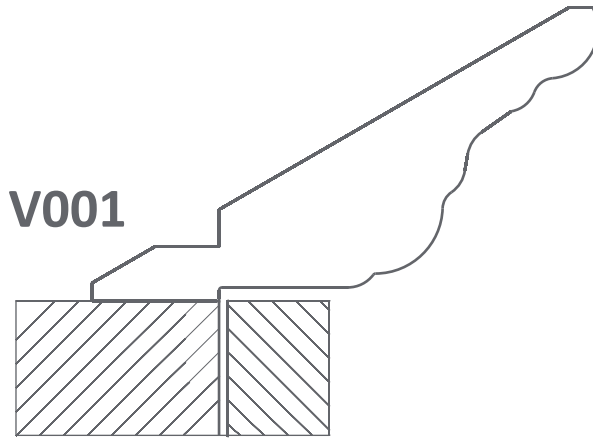

# Corniche

cornice

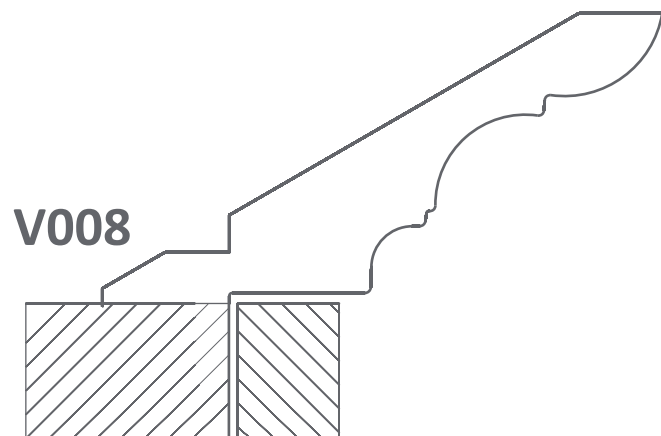
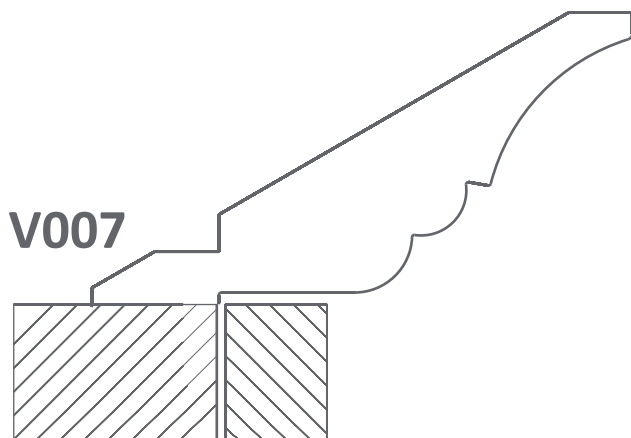
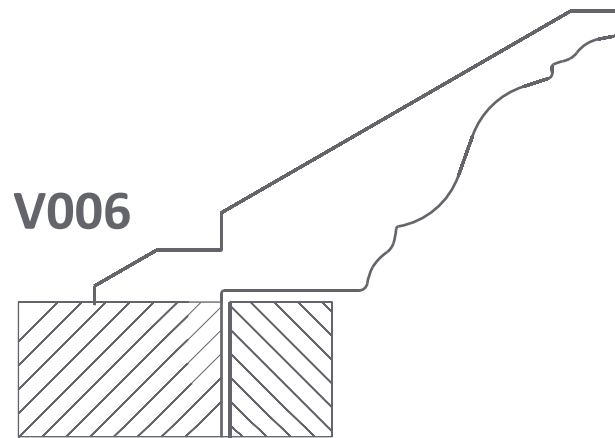
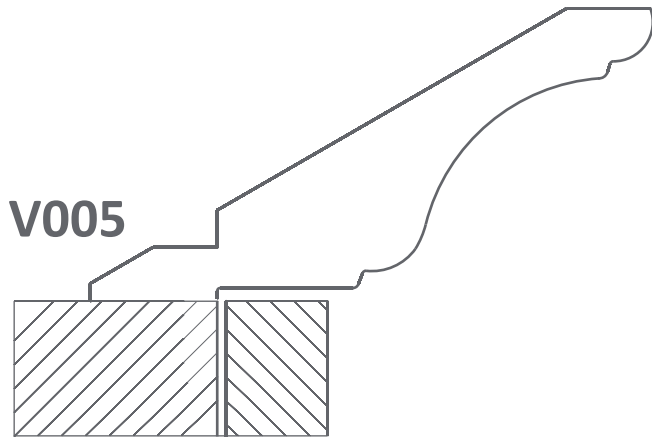



**sabec.ca**

T : 418-549-4087 sans frais : 800-565-3702  
F : 888-906-6732 ■ info@sabec.ca  
1321, rue Manic, Chicoutimi G7K 1G7